

1 2 3 4 5 6

A

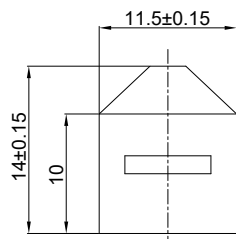

Dust Cap

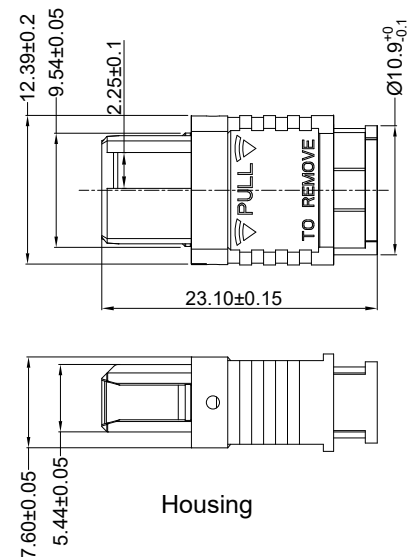

Housing

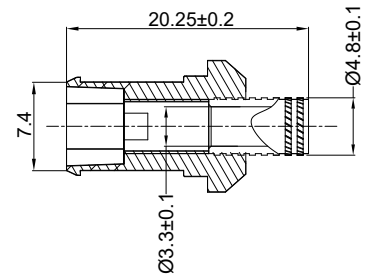

Spring Push

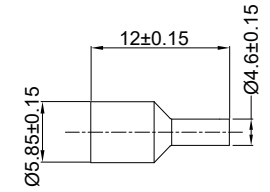

Crimp Ring

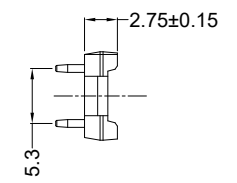

Female Pin Spacer

B

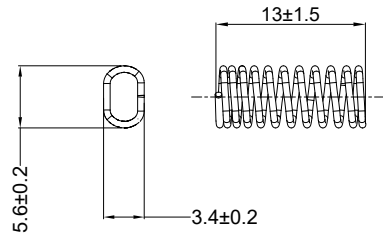

Spring

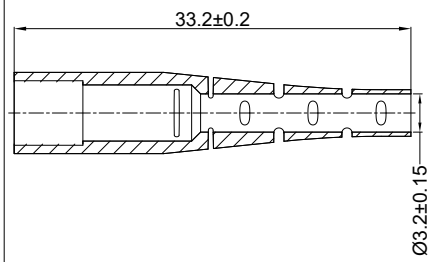

Boot

C

D

Name	MPO(16F/32F)3.0 Female Connector 60mm(T type)					Units	mm
Draw No.	MPOH .F.12F-0006					Scale	/
Drawn by	Tony	Date	2024-01-28	Material	/	Rev.	1.0
Checked by	HAN	Date	2024-01-28	Shenzhen Optico Communication Co; Ltd			
Approved by	Pearl	Date	2024-01-28				

1 2 3 4 5 6