

### Assembly Length tolerance:

Up to (m)	0.5	1	2	5	10	20	>20
Tolerance 0cm/+	5cm	5cm	10cm	20cm	30cm	30cm	2%

Label View	Label Example	PN/SN No.	Description
PN No. <span style="color: blue;">Label 1</span> Length(m)	30101206 2(m)	<span style="color: blue;">Client P/N or Vendor P/N</span>	Product No. Length(m)
SN <span style="color: blue;">Label 2</span> MTP +Polarity nn /qq	2522110170001 MTP +Polarity 1/100	<span style="color: blue;">S/N in Vendor' s system for tracking</span>	Seriel No. MTP+ Polarity Assembly No. of total amount

**Packing:** Each MTP assembly has to be packed individually in a ziplock PE bag (13" X 13"). For cable assembly with longer length(>80M), reel with appropriate size is needed.

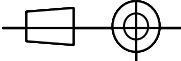

**OPTICO GROUP CO., LIMITED**

<b>Model</b>	MTP Trunk Master Cable 8F MTP(F) – MTP(M), G657A2 ,female-male, master cable					Client/Vendor System P/N			
<b>FIRST ANGLE PROJECTION</b> 	MATERIAL	UNIT	SCALE	SIZE	SHEET	DRAWN	Xueling. W	DATE	2025.10.17
	LSZH	m	/	A4	1	CHECKED	Xiaoqiang. Z	DATE	2025.10.17
							APPROVED	Zhimin. C	DATE

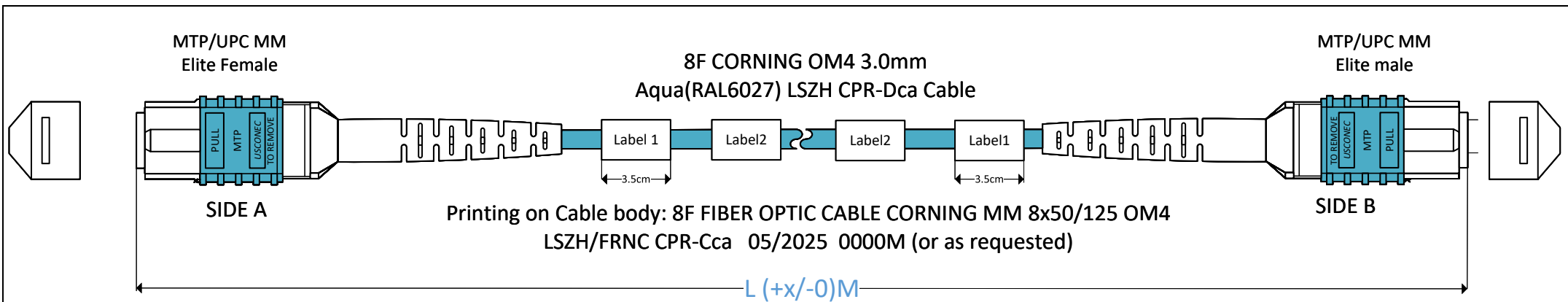

### Assembly Length tolerance:

Up to (m)	0.5	1	2	5	10	20	>20
Tolerance 0cm/+	5cm	5cm	10cm	20cm	30cm	30cm	2%

Label View	Label Example	PN/SN No.	Description
PN No. <span style="color: blue;">Label 1</span> Length(m)	30101206 2(m)	<span style="color: blue;">Client P/N or Vendor P/N</span>	Product No. Length(m)
SN <span style="color: blue;">Label 2</span> MTP +Polarity nn /qq	2522110170001 MTP +Polarity 1/100	<span style="color: blue;">S/N in Vendor' s system for tracking</span>	Serial No. MTP+ Polarity Assembly No. of total amount

**Packing:** Each MTP assembly has to be packed individually in a ziplock PE bag (13" X 13"). For cable assembly with longer length(>80M), reel with appropriate size is needed.

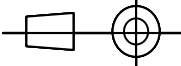
		<b>OPTICO GROUP CO., LIMITED</b>							
Model	MTP Trunk Master Cable 8F MTP(F) – MTP(M), OM4,female-male, master cable						Client/Vendor System P/N		
FIRST ANGLE PROJECTION 	MATERIAL	UNIT	SCALE	SIZE	SHEET	DRAWN	Xueling. W	DATE	2025.10.17
	LSZH	m	/	A4	1	CHECKED	Xiaoqiang. Z	DATE	2025.10.17
							APPROVED	Zhimin. C	DATE

# TIA Type Definition

## Straight Configuration

Type A : Same colored fibers have same position.

Type A (TIA)

Fiber No.		Color
SIDE A	SIDE B	
1	1	BLUE
2	2	ORANGE
3	3	GREEN
4	4	BROWN
5	5	Non
6	6	Non
7	7	Non
8	8	Non
9	9	YELLOW
10	10	VIOLET
11	11	PINK
12	12	AQUA

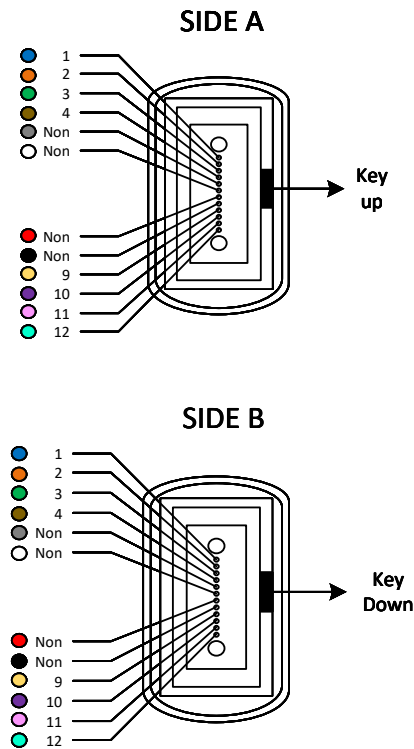

## Crossed configuration

Type B : Same colored fibers in different position; mirror inverted.

Type B (TIA)

Fiber No.		Color
SIDE A	SIDE B	
1	12	BLUE
2	11	ORANGE
3	10	GREEN
4	9	BROWN
5	8	Non
6	7	Non
7	6	Non
8	5	Non
9	4	YELLOW
10	3	VIOLET
11	2	PINK
12	1	AQUA

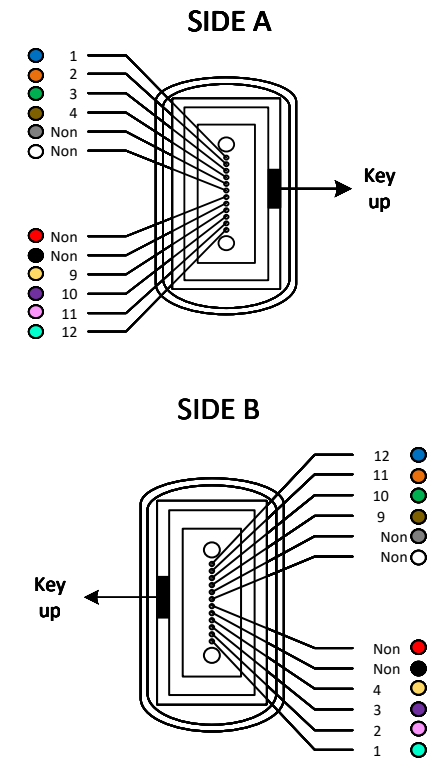

FIRST ANGLE PROJECTION		TIA Type Definition(8F MTP)							
	MATERIAL	UNIT	SCALE	SIZE	SHEET	DRAWN	Xueling. W	DATE	2025.10.17
	LSZH	m	/	A4	1	CHECKED	Xiaoqiang. Z	DATE	2025.10.17
						APPROVED	Zhimin. C	DATE	2025.10.17

# Optical Characteristics(applied to 12F MTP)

Item	Parameter		Reference
	Standard SM	Standard MM	
Insertion loss typ.	$\leq 0.12\text{dB}$	$\leq 0.1\text{dB}$	IEC 61300-3-4
Insertion loss max.	$\leq 0.2\text{dB}$	$\leq 0.15\text{dB}$	
Return loss	$\geq 70\text{dB(APC)}$ $\geq 50\text{dB(UPC)}$	$\geq 35\text{dB}$	IEC 61300-3-6

Connector Type	Reference	Note
MTP( Us Conec)	IEC 6154-7	Boot Color: Black Body Sleeve: MM(Aqua, Magenta, Lime Green), SM(Green Yellow)

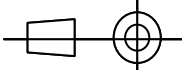
		OPTICAL CHARACTERISTICS(8F MTP)							
FIRST ANGLE PROJECTION 	MATERIAL	UNIT	SCALE	SIZE	SHEET	DRAWN	Xueling. W	DATE	2025.10.17
	LSZH	m	/	A4	1	CHECKED	Xiaoqiang. Z	DATE	2025.10.17
						APPROVED	Zhimin. C	DATE	2025.10.17

# End-surface Geonetry(applied to 12F MTP)

Item	Parameter	Reference
Minus Coplanarity	$\leq 0.3\mu\text{m}$	IEC 61755-3-31: 2015
Ferrule Surface X-Angle	$-0.10^\circ \sim +0.10^\circ$	
Ferrule Surface Y-Angle	$7.8^\circ \sim 8.2^\circ$	
Ferrule Height	1.5um to 2.5um	
Fiber Differential Height-All	$\leq 0.3\mu\text{m}$	
Fiber Differential Height-Adj.	$\leq 0.2\mu\text{m}$	
Fiber Tip Spherical Radius	$\geq 1\text{mm}$	
Fiber Surface X-Radius	$\geq 2000\text{mm}$	
Fiber Surface Y-Radius	$\geq 50\text{mm}$	
Core Dip(For MM)	$\pm 0.1\mu\text{m}$	
Geometry Limit	$\leq 10$	

## End-surface Quality

Zone	Range(um)	Scratches	Defects	Reference
A	SM:0-25um MM:0-65um	None	None	IEC 61300-3-35:2015
B	SM:25-115um MM:65-115um	>1um, not allowed $\leq 1\mu\text{m}$ , 1 spot allowed	>1um, not allowed $\leq 1\mu\text{m}$ , 1 spot allowed	
C	SM:115-135um MM:115-135um	>1um, not allowed $\leq 1\mu\text{m}$ , 1 spot allowed	>2um, not allowed $\leq 2\mu\text{m}$ , 1 spot allowed	
D	SM:>250um MM>250um	>2um, not allowed $\leq 2\mu\text{m}$ , 2 spot allowed	>3um, not allowed $\leq 3\mu\text{m}$ , 2 spot allowed	

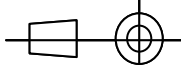
	<b>END-SURFACE GEOMETRY(8F MTP)</b>									
	FIRST ANGLE PROJECTION  	MATERIAL	UNIT	SCALE	SIZE	SHEET	DRAWN	Xueling. W	DATE	2025.10.17
		LSZH	m	/	A4	1	CHECKED	Xiaoqiang. Z	DATE	2025.10.17
						APPROVED	Zhimin. C	DATE	2025.10.17	

# Optical Specifications

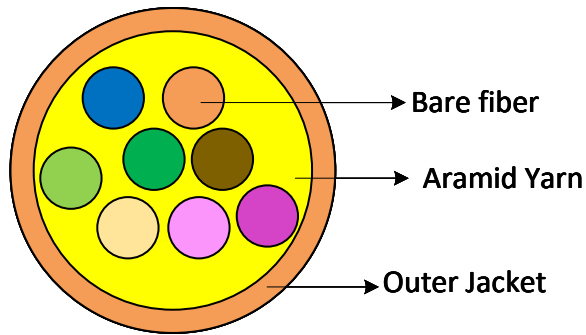

Cable Structure

## Cable Parameter

Fiber count		8		
Outer Diameter(mm)		2.95±0.1		
Thickness(mm)		0.50±0.05		
Max. tensile strength (N)	Short-term	200		
	Long-term	100		
Min. bending Radius (mm)	Dynamic	20D		
	Static	10D		
Material		PVC	LSZH	OFNP
Nominal weight(Kg/km)		7.2	7.6	8.1
Operation Temperature(°C)		-10~+60		
Storage Temperature(°C)		-20~+70		
Max. crush resistance (N/100mm <sup>2</sup> )	Short-term	500		
	Long-term	150		

		<h3>CABLE SPECIFICATION(8F round cable)</h3>							
FIRST ANGLE PROJECTION 	MATERIAL	UNIT	SCALE	SIZE	SHEET	DRAWN	Xueling. W	DATE	2025.10.17
	LSZH	m	/	A4	1	CHECKED	Xiaoqiang. Z	DATE	2025.10.17
						APPROVED	Zhimin. C	DATE	2025.10.17

# Optical Specifications

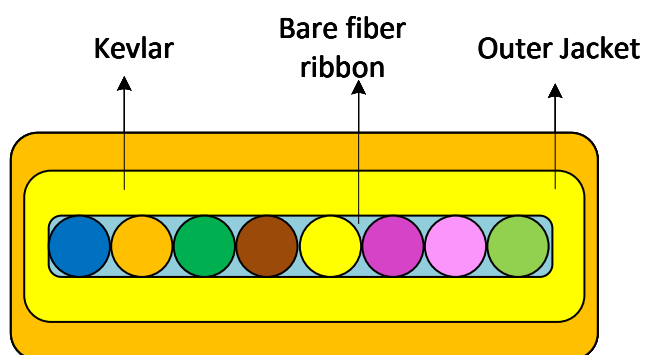

Cable Structure

## Cable Parameter

Fiber count		8		
Outer Dimension(mm)		2.5*4.5		
Thickness(mm)		0.50±0.05		
Max. tensile strength (N)	Short-term	200		
	Long-term	80		
Min. bending Radius (mm)	Dynamic	35H		
	Static	25H		
Material		PVC	LSZH	OFNP
Nominal weight(Kg/km)		10.0		
Operation Temperature(°C)		-10~+60		
Storage Temperature(°C)		-20~+70		
Max. crush resistance (N/100mm <sup>2</sup> )	Short-term	200		
	Long-term	80		

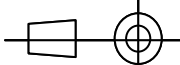
		<h3>CABLE SPECIFICATION(8F ribbon cable)</h3>							
FIRST ANGLE PROJECTION 	MATERIAL	UNIT	SCALE	SIZE	SHEET	DRAWN	Xueling. W	DATE	2025.10.17
	LSZH	m	/	A4	1	CHECKED	Xiaoqiang. Z	DATE	2025.10.17
						APPROVED	Zhimin. C	DATE	2025.10.17