

SIDE B	1	2	3	4	5	6	7	8	9	10	11	12
LC	Blue	Orange	Green	Brown	Grey	White	Red	Black	Yellow	Violet	Pink	Aqua
SIDE B	13	14	15	16	17	18	19	20	21	22	23	24
LC	Blue	Orange	Green	Brown	Grey	White	Red	Black	Yellow	Violet	Pink	Aqua

Specification:

- 1.Low Loss IL: $\leq 0.35\text{dB}$; Ultra loss: $\leq 0.25\text{dB}$;
- 2.Return Loss: $\geq 65\text{dB}$
- 3.Operation Environment: $-40\sim+85^{\circ}\text{C}$
- 4.Storage Environment: $-40\sim+85^{\circ}\text{C}$



SHENZHEN OPTICO COMMUNICATION CO., LTD.

Model	24F MTPAPC Female-LCUPC Type U SM G657.A 3.0mm Yellow LSZH CPR-Dca Cable					O-24F-MTPFALCU-SM-U			
FIRST ANGLE PROJECTION	MATERIAL	UNIT	SCALE	SIZE	SHEET	DRAWN	XUELING W	DATE	2025.04.25
	LSZH	m	/	A4	1	CHECKED	Michael Liu	DATE	2025.04.25
						APPROVED	STEVEN Zhang	DATE	2025.04.25

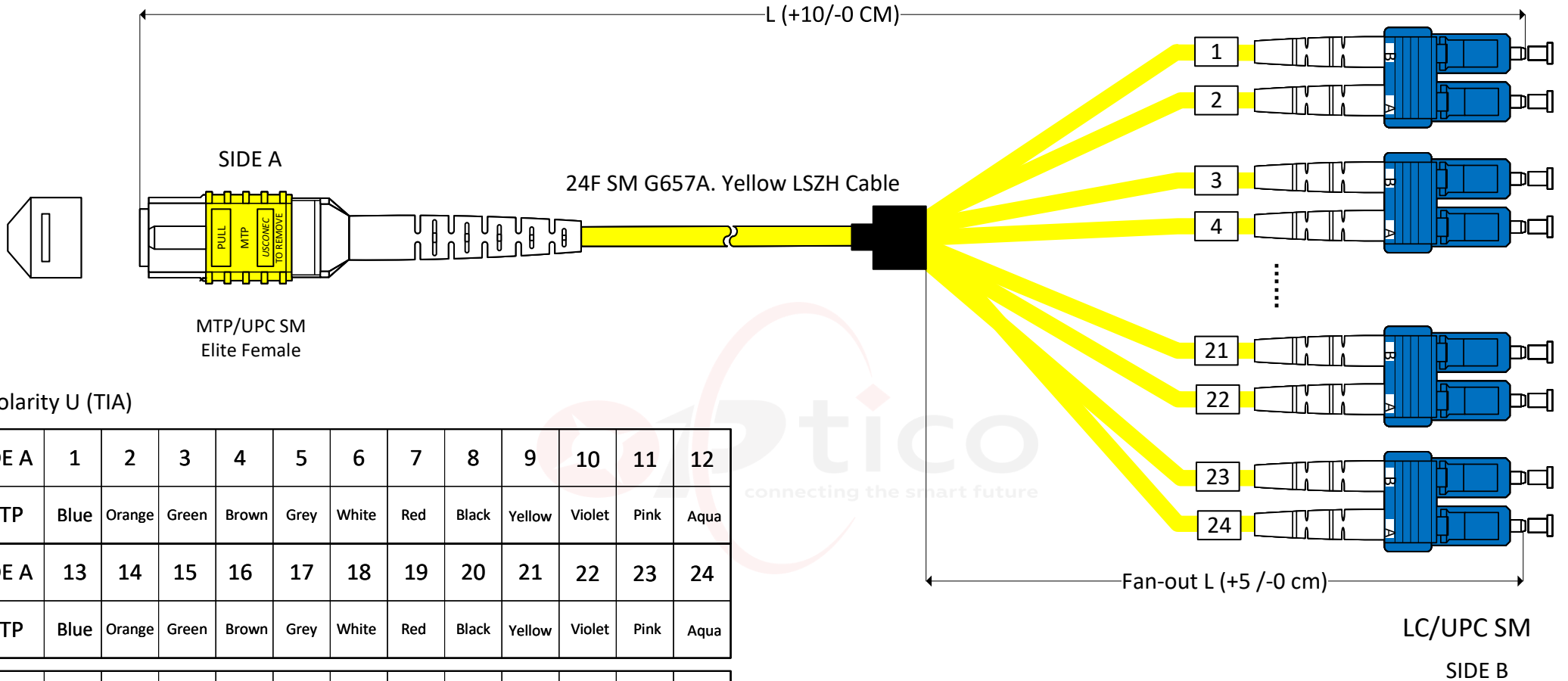

Polarity U (TIA)

SIDE A	1	2	3	4	5	6	7	8	9	10	11	12
MTP	Blue	Orange	Green	Brown	Grey	White	Red	Black	Yellow	Violet	Pink	Aqua
SIDE A	13	14	15	16	17	18	19	20	21	22	23	24
MTP	Blue	Orange	Green	Brown	Grey	White	Red	Black	Yellow	Violet	Pink	Aqua

SIDE B	1	2	3	4	5	6	7	8	9	10	11	12
LC	Blue	Orange	Green	Brown	Grey	White	Red	Black	Yellow	Violet	Pink	Aqua
SIDE B	13	14	15	16	17	18	19	20	21	22	23	24
LC	Blue	Orange	Green	Brown	Grey	White	Red	Black	Yellow	Violet	Pink	Aqua

Specification:

- 1.Low Loss IL: $\leq 0.35\text{dB}$; Ultra loss: $\leq 0.25\text{dB}$;
- 2.Return Loss: $\geq 65\text{dB}$
- 3.Operation Environment: $-40\sim+85^{\circ}\text{C}$
- 4.Storage Environment: $-40\sim+85^{\circ}\text{C}$

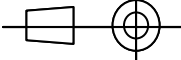
		SHENZHEN OPTICO COMMUNICATION CO., LTD.										
Model	24F MTPUPC Female-LCUPC Type U SM G657.A 3.0mm Yellow LSZH CPR-Dca Cable						OP-24F-MTPFLCU-SM-U					
FIRST ANGLE PROJECTION 	MATERIAL	UNIT	SCALE	SIZE	SHEET	DRAWN	XUELING W	DATE	2025.04.25			
							CHECKED	Michael Liu	DATE	2025.04.25		
							APPROVED	STEVEN Zhang	DATE	2025.04.25		
LSZH		m	A4		1							

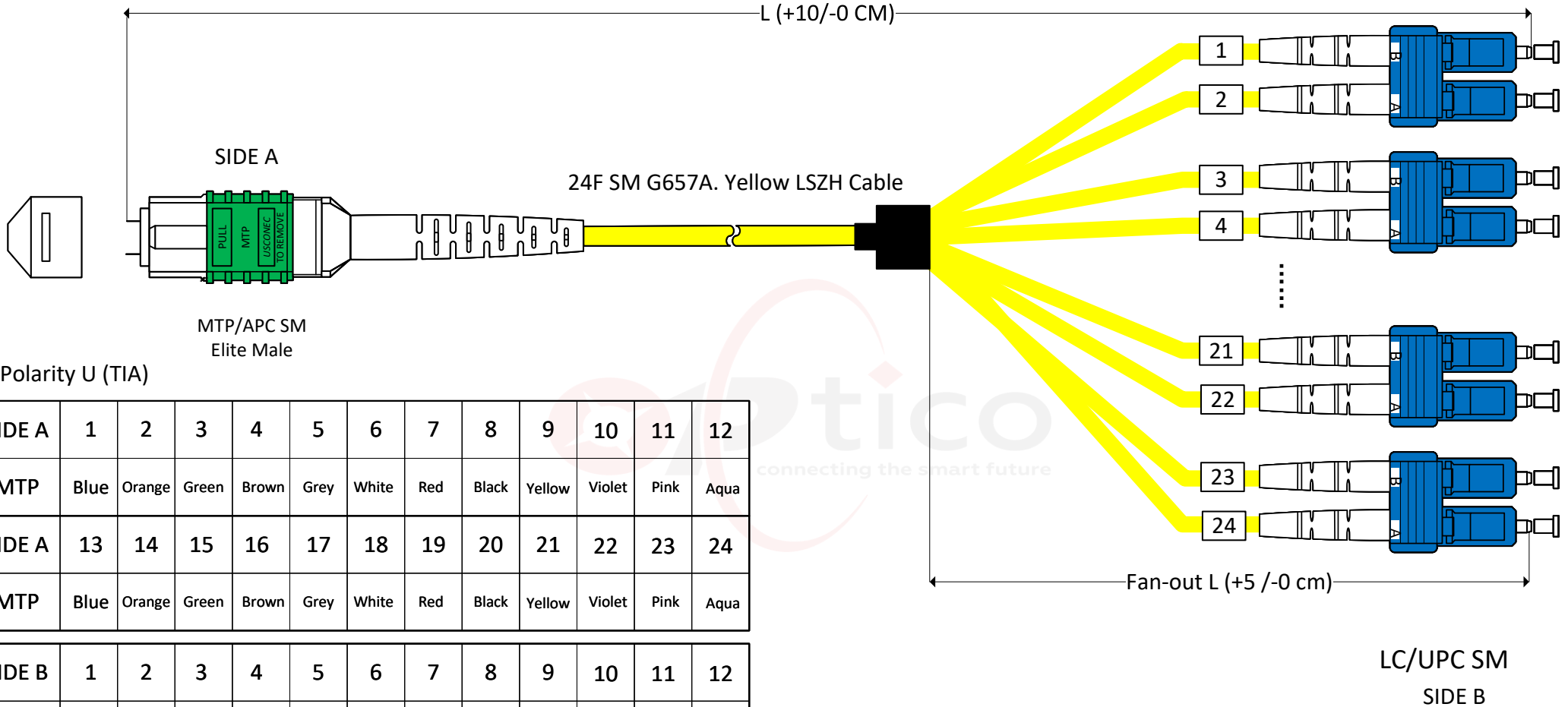

Polarity U (TIA)

SIDE A	1	2	3	4	5	6	7	8	9	10	11	12
MTP	Blue	Orange	Green	Brown	Grey	White	Red	Black	Yellow	Violet	Pink	Aqua
SIDE A	13	14	15	16	17	18	19	20	21	22	23	24
MTP	Blue	Orange	Green	Brown	Grey	White	Red	Black	Yellow	Violet	Pink	Aqua

SIDE B	1	2	3	4	5	6	7	8	9	10	11	12
LC	Blue	Orange	Green	Brown	Grey	White	Red	Black	Yellow	Violet	Pink	Aqua
SIDE B	13	14	15	16	17	18	19	20	21	22	23	24
LC	Blue	Orange	Green	Brown	Grey	White	Red	Black	Yellow	Violet	Pink	Aqua

Specification:

- 1.Low Loss IL: $\leq 0.35\text{dB}$; Ultra loss: $\leq 0.25\text{dB}$;
- 2.Return Loss: $\geq 65\text{dB}$
- 3.Operation Environment: $-40\sim+85^{\circ}\text{C}$
- 4.Storage Environment: $-40\sim+85^{\circ}\text{C}$

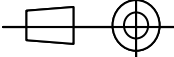
		SHENZHEN OPTICO COMMUNICATION CO., LTD.										
Model	24F MTPAPC Male-LCUPC Type U SM G657.A 3.0mm Yellow LSZH CPR-Dca Cable							OP-24F-MTPMALCU-SM-U				
FIRST ANGLE PROJECTION 	MATERIAL	UNIT	SCALE	SIZE	SHEET	DRAWN	XUELING W	DATE	2025.04.25			
	LSZH	m	/	A4	1	CHECKED	Michael Liu	DATE	2025.04.25			
						APPROVED	STEVEN Zhang	DATE	2025.04.25			

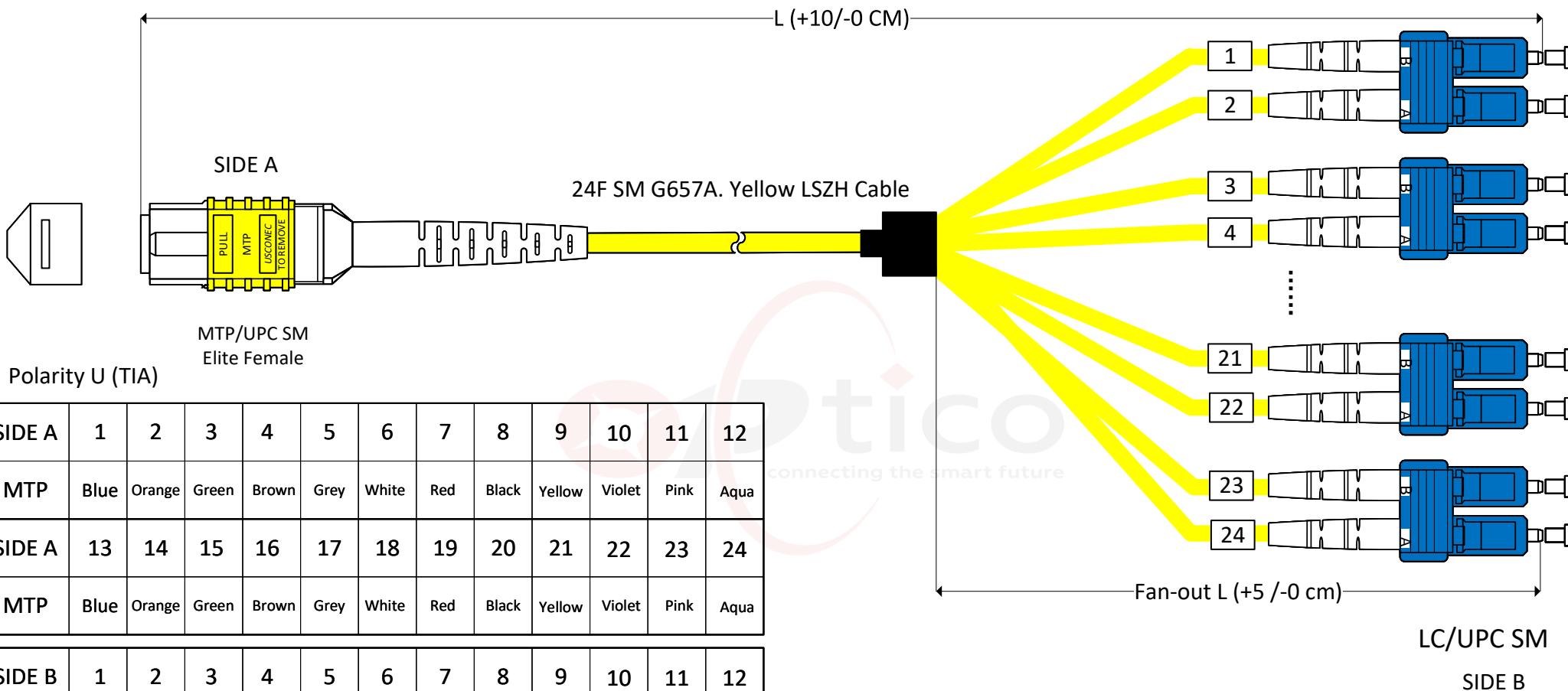

Polarity U (TIA)

SIDE A	1	2	3	4	5	6	7	8	9	10	11	12
MTP	Blue	Orange	Green	Brown	Grey	White	Red	Black	Yellow	Violet	Pink	Aqua
SIDE A	13	14	15	16	17	18	19	20	21	22	23	24
MTP	Blue	Orange	Green	Brown	Grey	White	Red	Black	Yellow	Violet	Pink	Aqua

SIDE B	1	2	3	4	5	6	7	8	9	10	11	12
LC	Blue	Orange	Green	Brown	Grey	White	Red	Black	Yellow	Violet	Pink	Aqua
SIDE B	13	14	15	16	17	18	19	20	21	22	23	24
LC	Blue	Orange	Green	Brown	Grey	White	Red	Black	Yellow	Violet	Pink	Aqua

Specification:

- 1.Low Loss IL: $\leq 0.35\text{dB}$; Ultra loss: $\leq 0.25\text{dB}$;
- 2.Return Loss: $\geq 65\text{dB}$
- 3.Operation Environment: $-40\sim+85^{\circ}\text{C}$
- 4.Storage Environment: $-40\sim+85^{\circ}\text{C}$

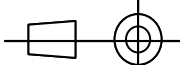

SHENZHEN OPTICO COMMUNICATION CO., LTD.

Model	24F MTPUPC Male-LCUPC Type U SM G657.A 3.0mm Yellow LSZH CPR-Dca Cable					OP-24F-MTPMULCU-SM-U			
FIRST ANGLE PROJECTION 	MATERIAL	UNIT	SCALE	SIZE	SHEET	DRAWN	XUELING W	DATE	2025.04.25
						CHECKED	Michael Liu	DATE	2025.04.25
						APPROVED	STEVEN Zhang	DATE	2025.04.25

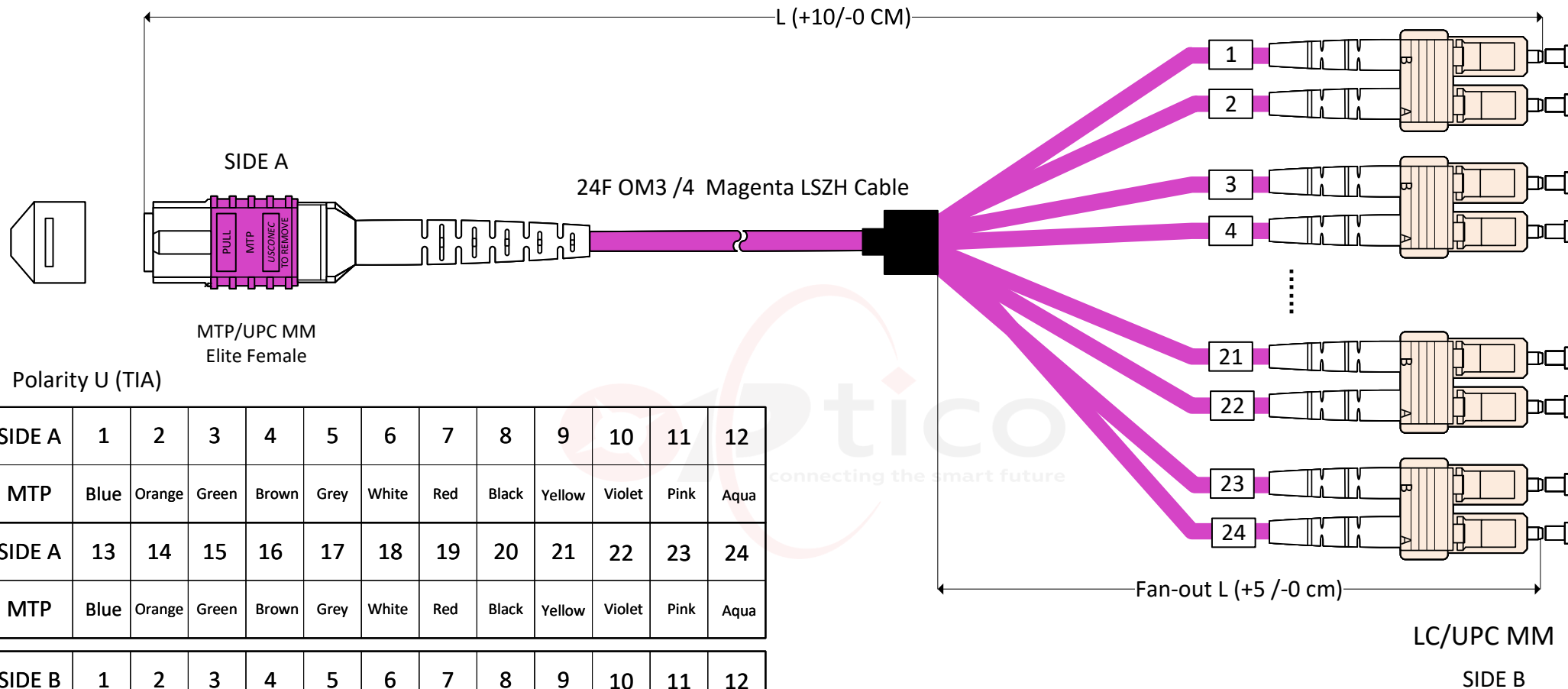

Polarity U (TIA)

SIDE A	1	2	3	4	5	6	7	8	9	10	11	12
MTP	Blue	Orange	Green	Brown	Grey	White	Red	Black	Yellow	Violet	Pink	Aqua
SIDE A	13	14	15	16	17	18	19	20	21	22	23	24
MTP	Blue	Orange	Green	Brown	Grey	White	Red	Black	Yellow	Violet	Pink	Aqua

SIDE B	1	2	3	4	5	6	7	8	9	10	11	12
LC	Blue	Orange	Green	Brown	Grey	White	Red	Black	Yellow	Violet	Pink	Aqua
SIDE B	13	14	15	16	17	18	19	20	21	22	23	24
LC	Blue	Orange	Green	Brown	Grey	White	Red	Black	Yellow	Violet	Pink	Aqua

Specification:

- 1.Low Loss IL: $\leq 0.35\text{dB}$; Ultra loss: $\leq 0.25\text{dB}$;
- 2.Return Loss: $\geq 35\text{dB}$
- 3.Operation Environment: $-40\sim+85^{\circ}\text{C}$
- 4.Storage Environment: $-40\sim+85^{\circ}\text{C}$

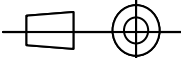
		SHENZHEN OPTICO COMMUNICATION CO., LTD.										
Model	24F MTPUPC Female-LCUPC Type U OM3 /4 3.0mm Magenta LSZH CPR-Dca Cable						O-24F-MTPFULCU-OM3/4-U					
FIRST ANGLE PROJECTION 	MATERIAL	UNIT	SCALE	SIZE	SHEET	DRAWN	XUELING W	DATE	2025.04.25			
						CHECKED	Michael Liu	DATE	2025.04.25			
	LSZH					m	/	A4	1	APPROVED	STEVEN Zhang	DATE

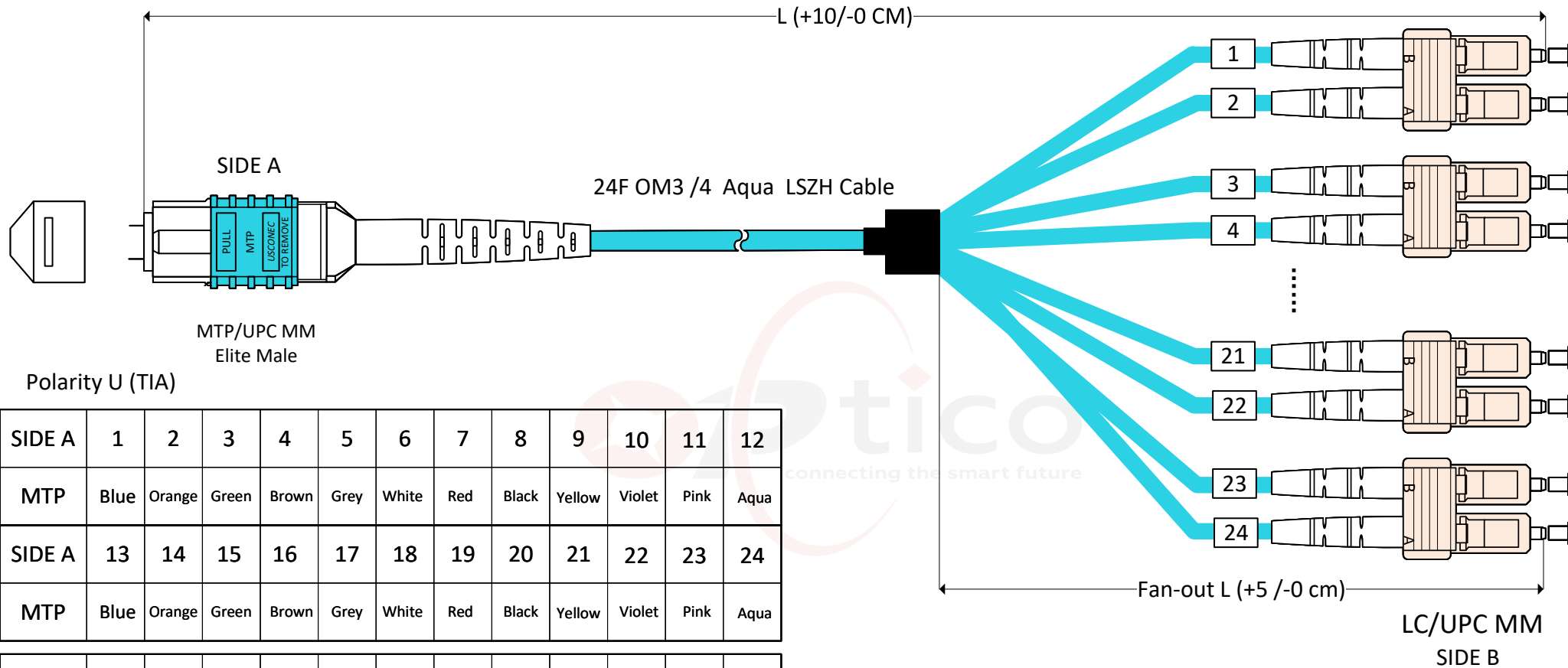

Polarity U (TIA)

SIDE A	1	2	3	4	5	6	7	8	9	10	11	12
MTP	Blue	Orange	Green	Brown	Grey	White	Red	Black	Yellow	Violet	Pink	Aqua
SIDE A	13	14	15	16	17	18	19	20	21	22	23	24
MTP	Blue	Orange	Green	Brown	Grey	White	Red	Black	Yellow	Violet	Pink	Aqua

SIDE B	1	2	3	4	5	6	7	8	9	10	11	12
LC	Blue	Orange	Green	Brown	Grey	White	Red	Black	Yellow	Violet	Pink	Aqua
SIDE B	13	14	15	16	17	18	19	20	21	22	23	24
LC	Blue	Orange	Green	Brown	Grey	White	Red	Black	Yellow	Violet	Pink	Aqua

Specification:

- 1.Low Loss IL: $\leq 0.35\text{dB}$; Ultra loss: $\leq 0.25\text{dB}$;
- 2.Return Loss: $\geq 35\text{dB}$
- 3.Operation Environment: $-40\sim+85^{\circ}\text{C}$
- 4.Storage Environment: $-40\sim+85^{\circ}\text{C}$

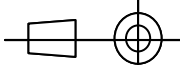

SHENZHEN OPTICO COMMUNICATION CO., LTD.

Model	24F MTPUPC Male-LCUPC Type U OM3/4 3.0mm Aqua LSZH CPR-Dca Cable	O-24F-MTPMULCU-OM3/4-U							
FIRST ANGLE PROJECTION 	MATERIAL	UNIT	SCALE	SIZE	SHEET	DRAWN	XUELING W	DATE	2025.04.25
	LSZH	m	/	A4	1	CHECKED	Michael Liu	DATE	2025.04.25
						APPROVED	STEVEN Zhang	DATE	2025.04.25

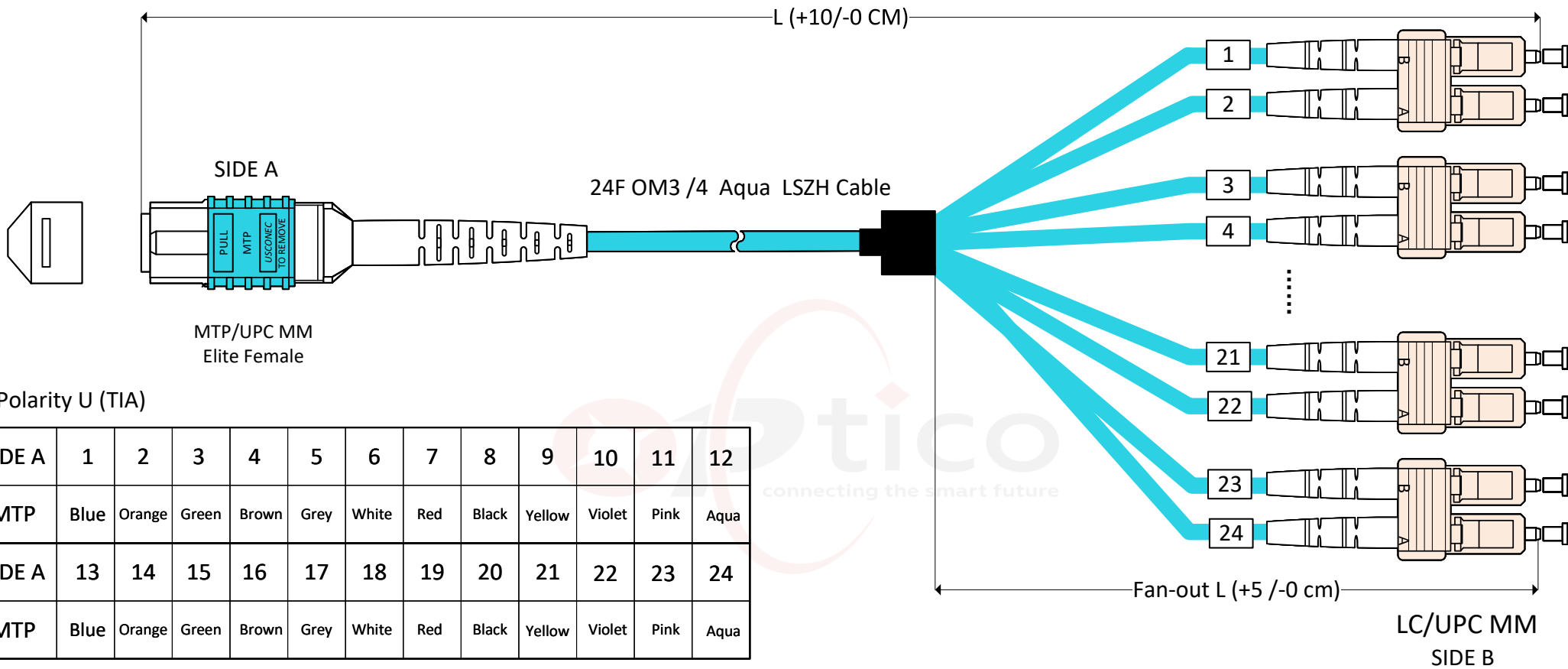

Polarity U (TIA)

SIDE A	1	2	3	4	5	6	7	8	9	10	11	12
MTP	Blue	Orange	Green	Brown	Grey	White	Red	Black	Yellow	Violet	Pink	Aqua
SIDE A	13	14	15	16	17	18	19	20	21	22	23	24
MTP	Blue	Orange	Green	Brown	Grey	White	Red	Black	Yellow	Violet	Pink	Aqua

SIDE B	1	2	3	4	5	6	7	8	9	10	11	12
LC	Blue	Orange	Green	Brown	Grey	White	Red	Black	Yellow	Violet	Pink	Aqua
SIDE B	13	14	15	16	17	18	19	20	21	22	23	24
LC	Blue	Orange	Green	Brown	Grey	White	Red	Black	Yellow	Violet	Pink	Aqua

Specification:

- 1.Low Loss IL: $\leq 0.35\text{dB}$; Ultra loss: $\leq 0.25\text{dB}$;
- 2.Return Loss: $\geq 35\text{dB}$
- 3.Operation Environment: $-40\sim+85^{\circ}\text{C}$
- 4.Storage Environment: $-40\sim+85^{\circ}\text{C}$

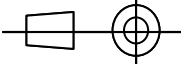
		SHENZHEN OPTICO COMMUNICATION CO., LTD.										
Model	24F MTPUPC Female-LCUPC Type U OM3 /4 3.0mm Aqua LSZH CPR-Dca Cable						O-24F-MTPFULCU-OM3/4-U					
FIRST ANGLE PROJECTION 	MATERIAL	UNIT	SCALE	SIZE	SHEET	DRAWN	XUELING W	DATE	2025.04.25			
						CHECKED	Michael Liu	DATE	2025.04.25			
	LSZH					m	/	A4	1	APPROVED	STEVEN Zhang	DATE

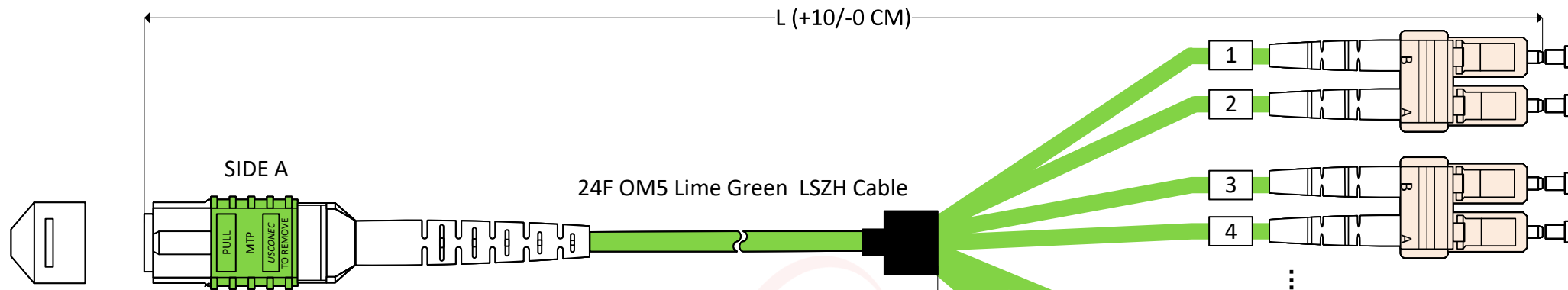

Polarity U (TIA)
MTP/UPC MM Elite Female

SIDE A	1	2	3	4	5	6	7	8	9	10	11	12
MTP	Blue	Orange	Green	Brown	Grey	White	Red	Black	Yellow	Violet	Pink	Aqua
SIDE A	13	14	15	16	17	18	19	20	21	22	23	24
MTP	Blue	Orange	Green	Brown	Grey	White	Red	Black	Yellow	Violet	Pink	Aqua

SIDE B	1	2	3	4	5	6	7	8	9	10	11	12
LC	Blue	Orange	Green	Brown	Grey	White	Red	Black	Yellow	Violet	Pink	Aqua
SIDE B	13	14	15	16	17	18	19	20	21	22	23	24
LC	Blue	Orange	Green	Brown	Grey	White	Red	Black	Yellow	Violet	Pink	Aqua

Specification:

- 1.Low Loss IL: $\leq 0.35\text{dB}$; Ultra loss: $\leq 0.25\text{dB}$;
- 2.Return Loss: $\geq 35\text{dB}$
- 3.Operation Environment: $-40\sim+85^{\circ}\text{C}$
- 4.Storage Environment: $-40\sim+85^{\circ}\text{C}$

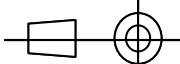

SHENZHEN OPTICO COMMUNICATION CO., LTD.

Model	24F MTPUPC Female-LCUPC Type U OM5 3.0mm Lime Green LSZH CPR-Dca Cable					O-24F-MTPFULCU-OM5-U			
FIRST ANGLE PROJECTION 	MATERIAL	UNIT	SCALE	SIZE	SHEET	DRAWN	XUELING W	DATE	2025.04.25
	LSZH	m	/	A4	1	CHECKED	Michael Liu	DATE	2025.04.25
						APPROVED	STEVEN Zhang	DATE	2025.04.25

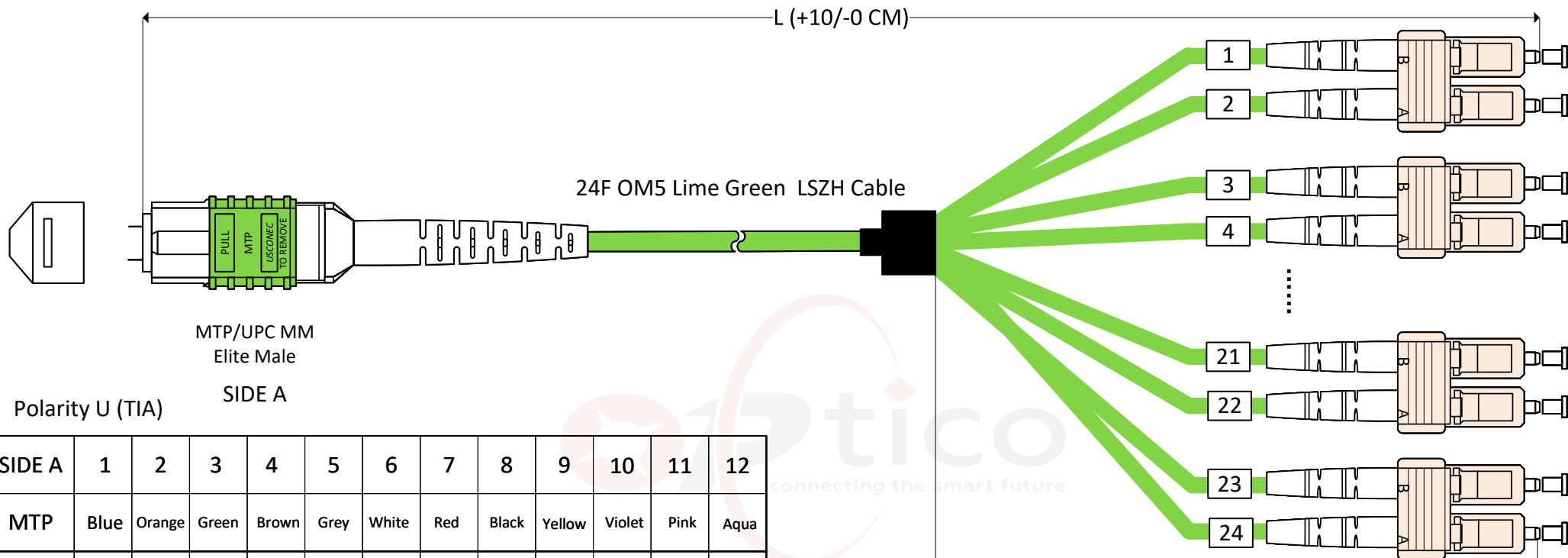

MTP/UPC MM
Elite Male

SIDE A

Polarity U (TIA)

SIDE A	1	2	3	4	5	6	7	8	9	10	11	12
MTP	Blue	Orange	Green	Brown	Grey	White	Red	Black	Yellow	Violet	Pink	Aqua
SIDE A	13	14	15	16	17	18	19	20	21	22	23	24
MTP	Blue	Orange	Green	Brown	Grey	White	Red	Black	Yellow	Violet	Pink	Aqua

SIDE B	1	2	3	4	5	6	7	8	9	10	11	12
LC	Blue	Orange	Green	Brown	Grey	White	Red	Black	Yellow	Violet	Pink	Aqua
SIDE B	13	14	15	16	17	18	19	20	21	22	23	24
LC	Blue	Orange	Green	Brown	Grey	White	Red	Black	Yellow	Violet	Pink	Aqua

LC/UPC MM
SIDE B

Specification:

- 1.Low Loss IL: $\leq 0.35\text{dB}$; Ultra loss: $\leq 0.25\text{dB}$;
- 2.Return Loss: $\geq 35\text{dB}$
- 3.Operation Environment: $-40\sim+85^{\circ}\text{C}$
- 4.Storage Environment: $-40\sim+85^{\circ}\text{C}$



SHENZHEN OPTICO COMMUNICATION CO., LTD.

Model	24F MTPUPC Male-LCUPC Type U OM5 3.0mm Lime Green LSZH CPR-Dca Cable					O-24F-MTPMULCU-OM5-U			
FIRST ANGLE PROJECTION 	MATERIAL	UNIT	SCALE	SIZE	SHEET	DRAWN	XUELING W	DATE	2025.04.25
	LSZH	m	/	A4	1	CHECKED	Michael Liu	DATE	2025.04.25
						APPROVED	STEVEN Zhang	DATE	2025.04.25