

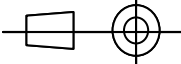

PLC Splitter Parameter		1x2
Operating Wavelength		1260~1650nm
Test Wavelength		1310/1490/1550nm
Insertion Loss	Max.	4.3 dB(including connectors)
PDL	Max.	0.2 dB
Uniformity	Max.	0.4 dB
Return Loss	Min.	55 dB
Directivity	Min.	55 dB
Operating Temperature		-40~+85°C
Storage Temperature		-40~+85°C
Fiber Type		G657A./As request
Connector Type		SCAPC/As request
Steel Tube Dimension		60*7*4mm

		SHENZHEN OPTICO COMMUNICATION CO., LTD.									
Model		PLC Splitter 1x2 Mini Type 900um loose tube with connectors					OP-102-900-XXM-SCA				
FIRST ANGLE PROJECTION 	MATERIAL	UNIT	SCALE	SIZE	SHEET	DRAWN	XUELING W	DATE	2025.06.10		
	LSZH	m	/	A4	1	CHECKED	Michael Liu	DATE	2025.06.10		
						APPROVED	STEVEN Zhang	DATE	2025.06.10		

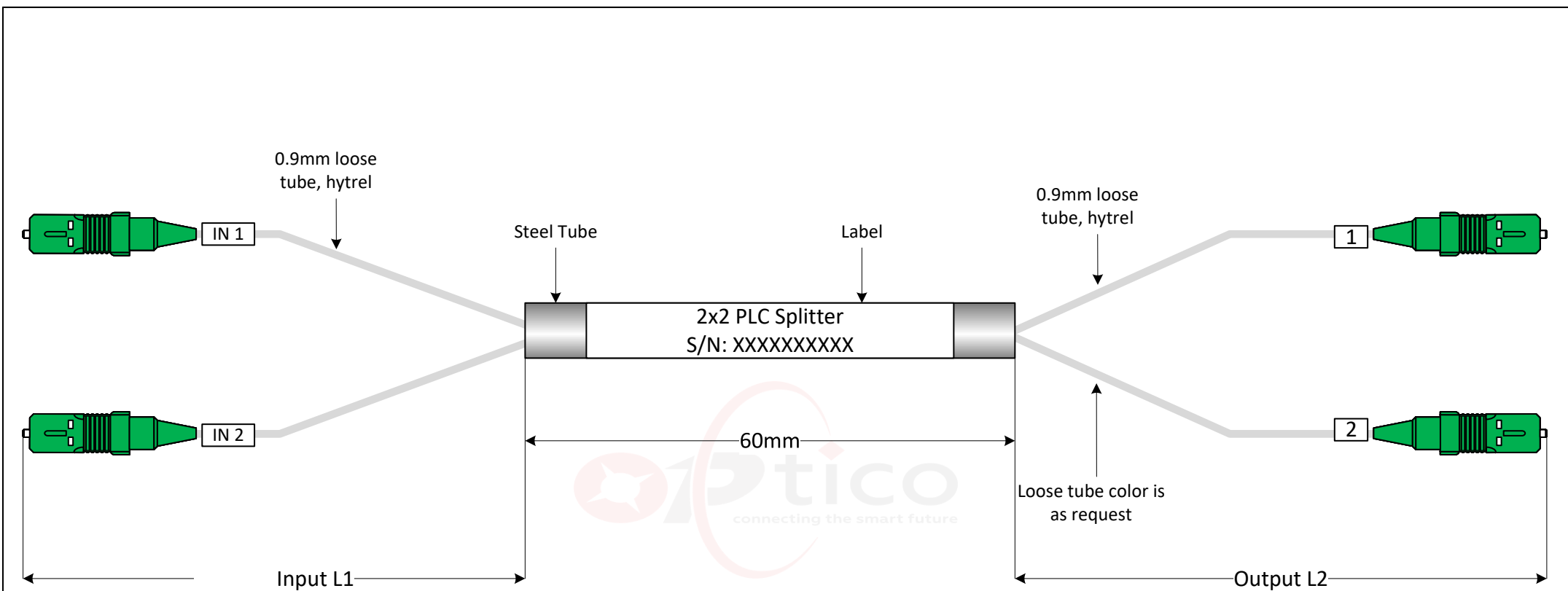

PLC Splitter Parameter		2x2
Operating Wavelength		1260~1650nm
Test Wavelength		1310/1490/1550nm
Insertion Loss	Max.	4.8 dB(including connectors)
PDL	Max.	0.3 dB
Uniformity	Max.	1.0 dB
Return Loss	Min.	55 dB
Directivity	Min.	55 dB
Operating Temperature		-40~+85°C
Storage Temperature		-40~+85°C
Fiber Type		G657A./As request
Connector Type		SCAPC/As request
Steel Tube Dimension		60*7*4mm

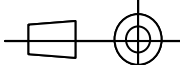
 SHENZHEN OPTICO COMMUNICATION CO., LTD.									
Model	PLC Splitter 2x2 Mini Type 900um loose tube with connectors	OP-202-900-XXM-SCA							
FIRST ANGLE PROJECTION 	MATERIAL	UNIT	SCALE	SIZE	SHEET	DRAWN	XUELING W	DATE	2025.06.10
	LSZH	m	/	A4	1	CHECKED	Michael Liu	DATE	2025.06.10
						APPROVED	STEVEN Zhang	DATE	2025.06.10

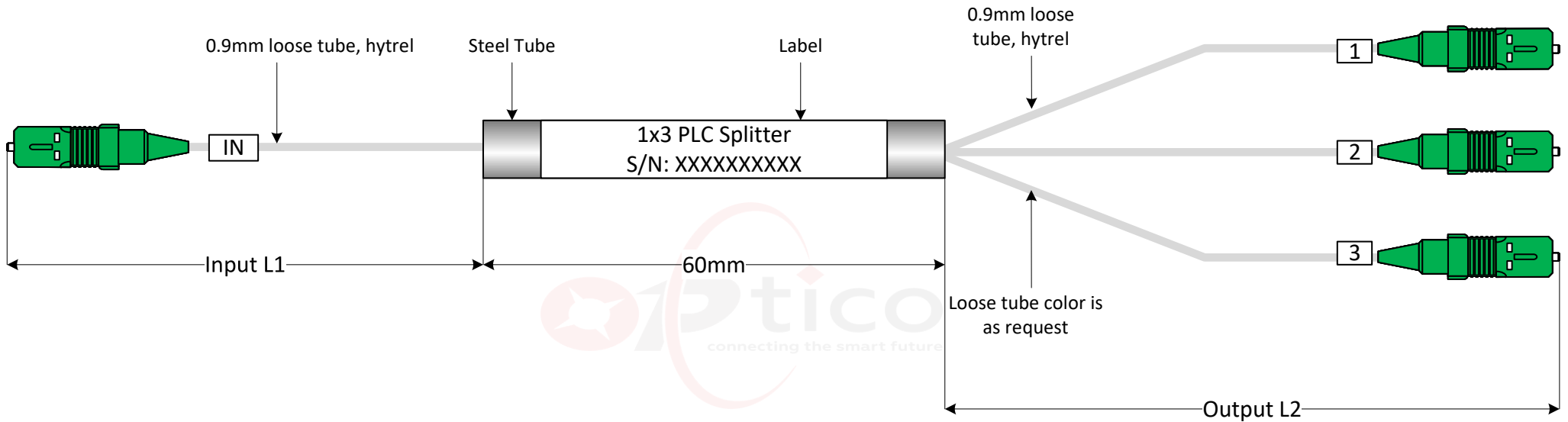

PLC Splitter Parameter		1x3
Operating Wavelength		1260~1650nm
Test Wavelength		1310/1490/1550nm
Insertion Loss	Max.	6.6 dB(including connectors)
PDL	Max.	0.2 dB
Uniformity	Max.	0.6 dB
Return Loss	Min.	55 dB
Directivity	Min.	55 dB
Operating Temperature		-40~+85°C
Storage Temperature		-40~+85°C
Fiber Type		G657A./As request
Connector Type		SCAPC/As request
Steel Tube Dimension		60*7*4mm

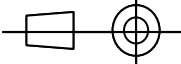
		SHENZHEN OPTICO COMMUNICATION CO., LTD.							
Model	PLC Splitter 1x3 Mini Type 900um loose tube with connectors						OP-103-900-XXM-SCA		
FIRST ANGLE PROJECTION 	MATERIAL	UNIT	SCALE	SIZE	SHEET	DRAWN	XUELING W	DATE	2025.06.10
	LSZH	m	/	A4	1	CHECKED	Michael Liu	DATE	2025.06.10
						APPROVED	STEVEN Zhang	DATE	2025.06.10

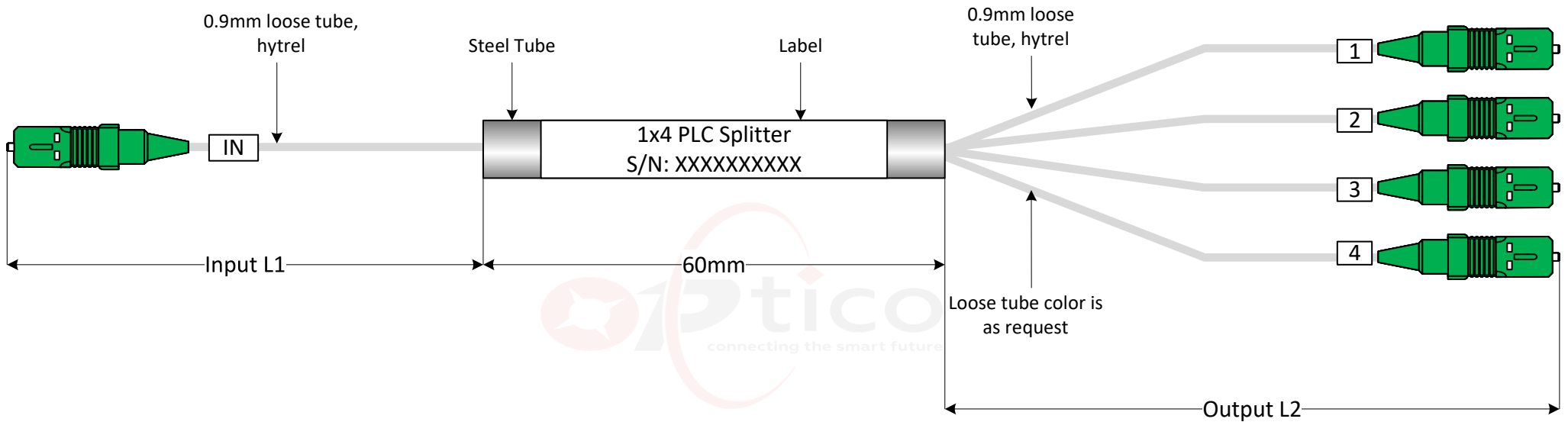

PLC Splitter Parameter		1x4
Operating Wavelength		1260~1650nm
Test Wavelength		1310/1490/1550nm
Insertion Loss	Max.	7.5 dB(including connectors)
PDL	Max.	0.2 dB
Uniformity	Max.	0.6 dB
Return Loss	Min.	55 dB
Directivity	Min.	55 dB
Operating Temperature		-40~+85°C
Storage Temperature		-40~+85°C
Fiber Type		G657A./As request
Connector Type		SCAPC/As request
Steel Tube Dimension		60*7*4mm

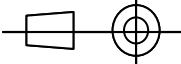
		SHENZHEN OPTICO COMMUNICATION CO., LTD.							
Model		PLC Splitter 1x4 Mini Type 900um loose tube with connectors					OP-104-900-XXM-SCA		
FIRST ANGLE PROJECTION 	MATERIAL	UNIT	SCALE	SIZE	SHEET	DRAWN	XUELING W	DATE	2025.06.10
	LSZH	m	/	A4	1	CHECKED	Michael Liu	DATE	2025.06.10
						APPROVED	STEVEN Zhang	DATE	2025.06.10

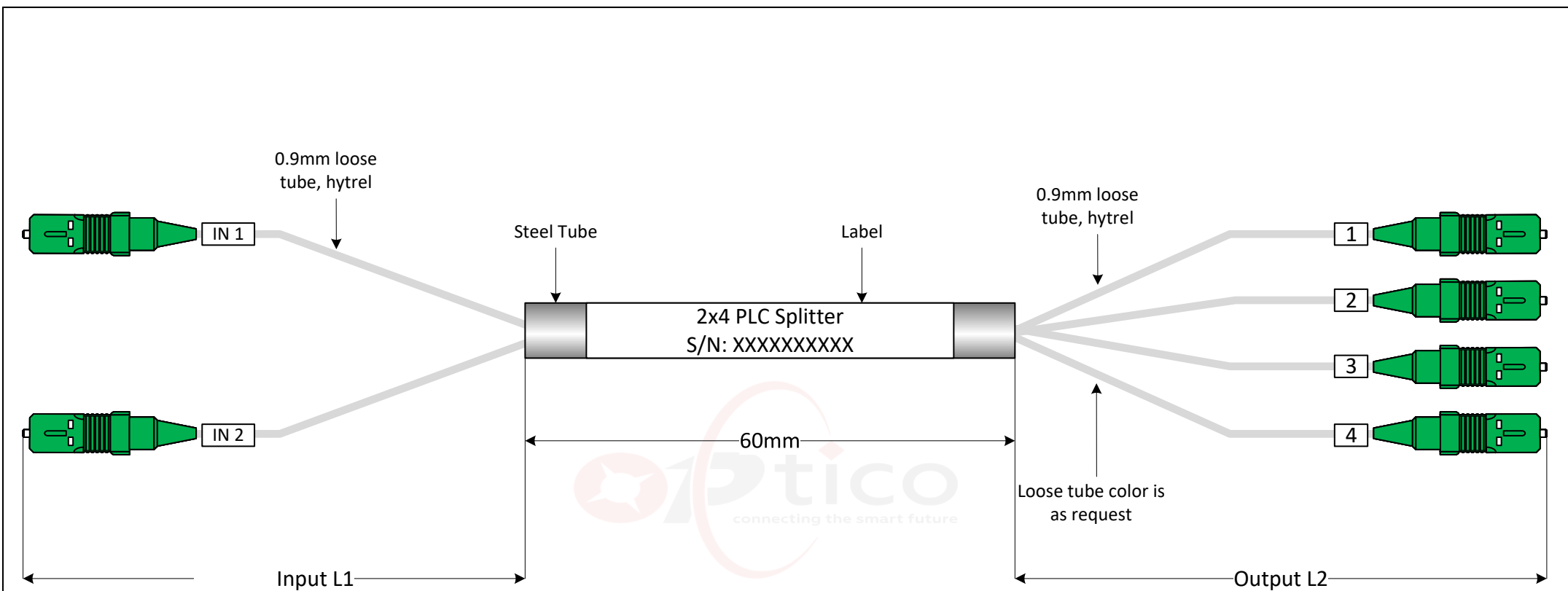

PLC Splitter Parameter		2x4
Operating Wavelength		1260~1650nm
Test Wavelength		1310/1490/1550nm
Insertion Loss	Max.	8.0 dB(including connectors)
PDL	Max.	0.3 dB
Uniformity	Max.	1.5 dB
Return Loss	Min.	55 dB
Directivity	Min.	55 dB
Operating Temperature		-40~+85°C
Storage Temperature		-40~+85°C
Fiber Type		G657A./As request
Connector Type		SCAPC/As request
Steel Tube Dimension		60*7*4mm

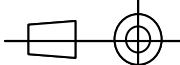
 SHENZHEN OPTICO COMMUNICATION CO., LTD.									
Model	PLC Splitter 2x4 Mini Type 900um loose tube with connectors	OP-204-900-XXM-SCA							
FIRST ANGLE PROJECTION 	MATERIAL	UNIT	SCALE	SIZE	SHEET	DRAWN	XUELING W	DATE	2025.06.10
	LSZH	m	/	A4	1	CHECKED	Michael Liu	DATE	2025.06.10
						APPROVED	STEVEN Zhang	DATE	2025.06.10

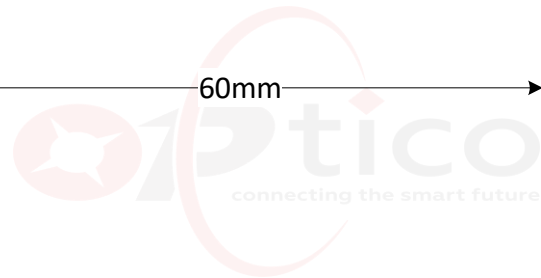
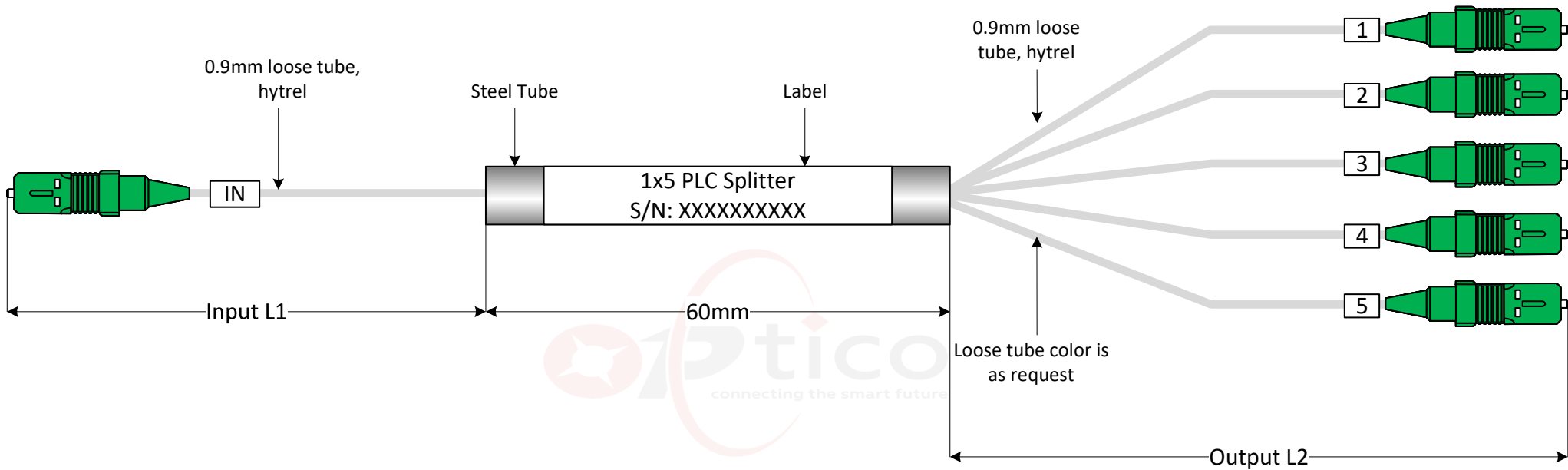

PLC Splitter Parameter		1x5(70%:30%/4)
Operating Wavelength		1260~1650nm
Test Wavelength		1310/1490/1550nm
Insertion Loss	Max.	3.7/13.2 dB(including connectors)
PDL	Max.	0.2 dB
Uniformity	Max.	0.6 dB
Return Loss	Min.	55 dB
Directivity	Min.	55 dB
Operating Temperature		-40~+85°C
Storage Temperature		-40~+85°C
Fiber Type		G657A./As request
Connector Type		SCAPC/As request
Steel Tube Dimension		60*7*4mm

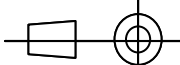
 SHENZHEN OPTICO COMMUNICATION CO., LTD.									
Model	PLC Splitter 1x5 Mini Type 900um loose tube with connectors	OP-105-900-XXM-SCA							
FIRST ANGLE PROJECTION 	MATERIAL	UNIT	SCALE	SIZE	SHEET	DRAWN	XUELING W	DATE	2025.06.10
	LSZH	m	/	A4	1	CHECKED	Michael Liu	DATE	2025.06.10
							APPROVED	STEVEN Zhang	DATE

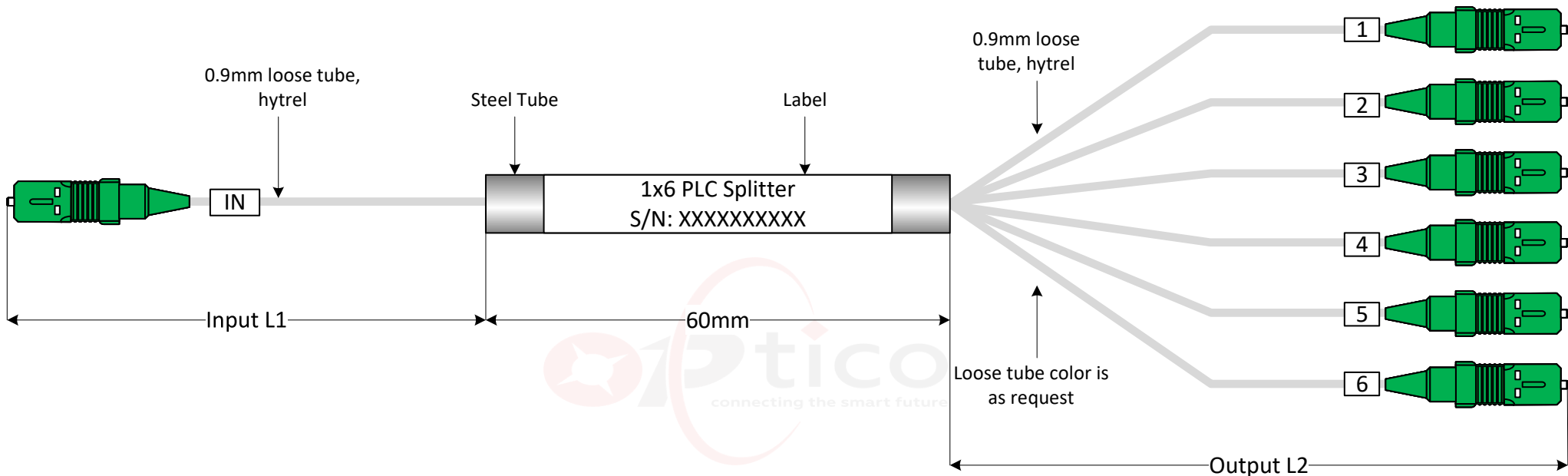

PLC Splitter Parameter		1x6
Operating Wavelength		1260~1650nm
Test Wavelength		1310/1490/1550nm
Insertion Loss	Max.	9.7 dB(including connectors)
PDL	Max.	0.2 dB
Uniformity	Max.	0.6 dB
Return Loss	Min.	55 dB
Directivity	Min.	55 dB
Operating Temperature		-40~+85°C
Storage Temperature		-40~+85°C
Fiber Type		G657A./As request
Connector Type		SCAPC/As request
Steel Tube Dimension		60*7*4mm

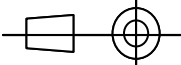
		SHENZHEN OPTICO COMMUNICATION CO., LTD.							
Model	PLC Splitter 1x6 Mini Type 900um loose tube with connectors						OP-106-900-XXM-SCA		
FIRST ANGLE PROJECTION 	MATERIAL	UNIT	SCALE	SIZE	SHEET	DRAWN	XUELING W	DATE	2025.06.10
	LSZH	m	/	A4	1	CHECKED	Michael Liu	DATE	2025.06.10
						APPROVED	STEVEN Zhang	DATE	2025.06.10

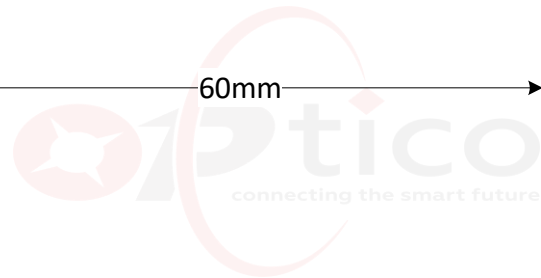
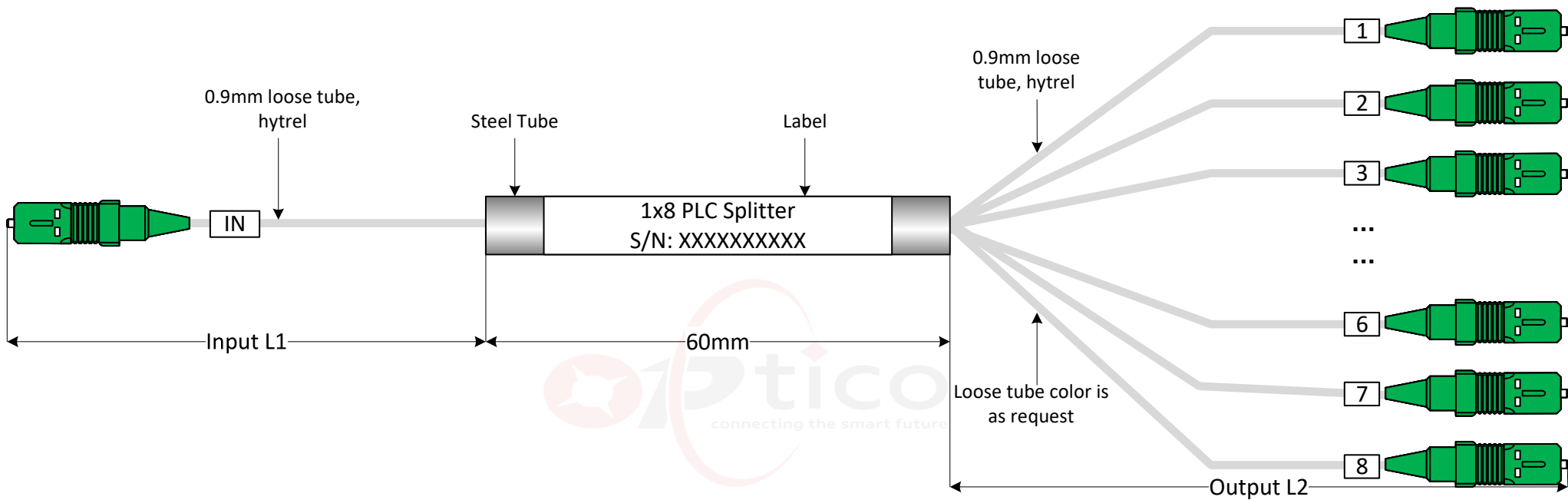

PLC Splitter Parameter		1x8
Operating Wavelength		1260~1650nm
Test Wavelength		1310/1490/1550nm
Insertion Loss	Max.	10.8 dB (including connectors)
PDL	Max.	0.2 dB
Uniformity	Max.	0.8 dB
Return Loss	Min.	55 dB
Directivity	Min.	55 dB
Operating Temperature		-40~+85°C
Storage Temperature		-40~+85°C
Fiber Type		G657A./As request
Connector Type		SCAPC/As request
Steel Tube Dimension		60*7*4mm

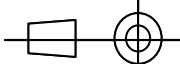
 SHENZHEN OPTICO COMMUNICATION CO., LTD.									
Model	PLC Splitter 1x8 Mini Type 900um loose tube with connectors	OP-108-900-XXM-SCA							
FIRST ANGLE PROJECTION 	MATERIAL	UNIT	SCALE	SIZE	SHEET	DRAWN	XUELING W	DATE	2025.06.10
	LSZH	m	/	A4	1	CHECKED	Michael Liu	DATE	2025.06.10
						APPROVED	STEVEN Zhang	DATE	2025.06.10

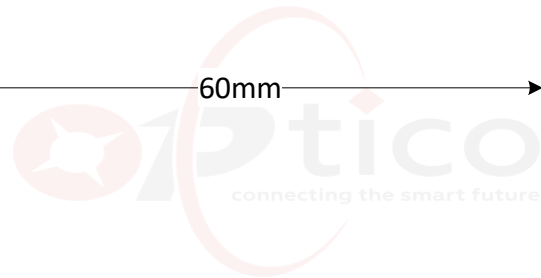
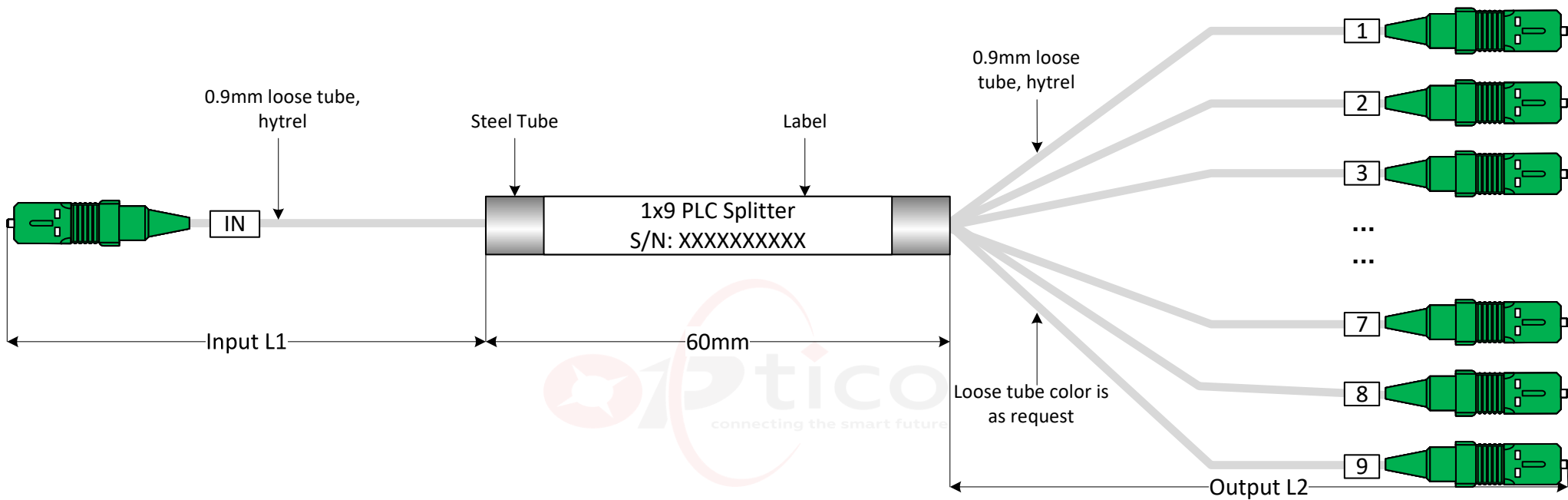

PLC Splitter Parameter		1x9 (70%: 30%/8)
Operating Wavelength		1260~1650nm
Test Wavelength		1310/1490/1550nm
Insertion Loss	Max.	2.6/16.6 dB(including connectors)
PDL	Max.	0.2 dB
Uniformity	Max.	0.8 dB
Return Loss	Min.	55 dB
Directivity	Min.	55 dB
Operating Temperature		-40~+85°C
Storage Temperature		-40~+85°C
Fiber Type		G657A./As request
Connector Type		SCAPC/As request
Steel Tube Dimension		60*7*4mm

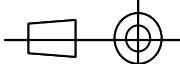
 SHENZHEN OPTICO COMMUNICATION CO., LTD.									
Model	PLC Splitter 1x9 Mini Type 900um loose tube with connectors	OP-109-900-XXM-SCA							
FIRST ANGLE PROJECTION 	MATERIAL	UNIT	SCALE	SIZE	SHEET	DRAWN	XUELING W	DATE	2025.06.10
	LSZH	m	/	A4	1	CHECKED	Michael Liu	DATE	2025.06.10
							APPROVED	STEVEN Zhang	DATE

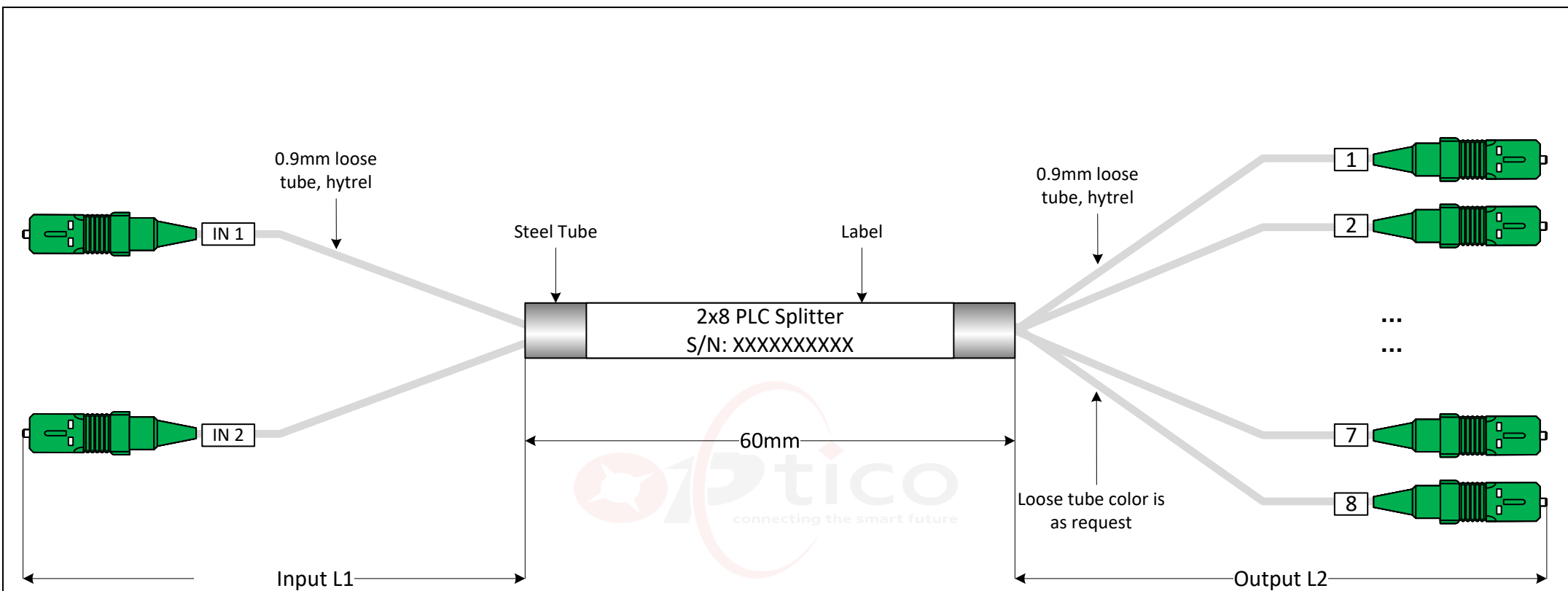

PLC Splitter Parameter		2x8
Operating Wavelength		1260~1650nm
Test Wavelength		1310/1490/1550nm
Insertion Loss	Max.	11.4 dB (including connectors)
PDL	Max.	0.3 dB
Uniformity	Max.	1.5 dB
Return Loss	Min.	55 dB
Directivity	Min.	55 dB
Operating Temperature		-40~+85°C
Storage Temperature		-40~+85°C
Fiber Type		G657A./As request
Connector Type		SCAPC/As request
Steel Tube Dimension		60*7*4mm

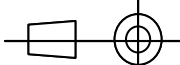

SHENZHEN OPTICO COMMUNICATION CO., LTD.

Model	PLC Splitter 2x8 Mini Type 900um loose tube with connectors					OP-208-900-XXM-SCA			
FIRST ANGLE PROJECTION 	MATERIAL	UNIT	SCALE	SIZE	SHEET	DRAWN	XUELING W	DATE	2025.06.10
	LSZH	m	/	A4	1	CHECKED	Michael Liu	DATE	2025.06.10
							APPROVED	STEVEN Zhang	DATE

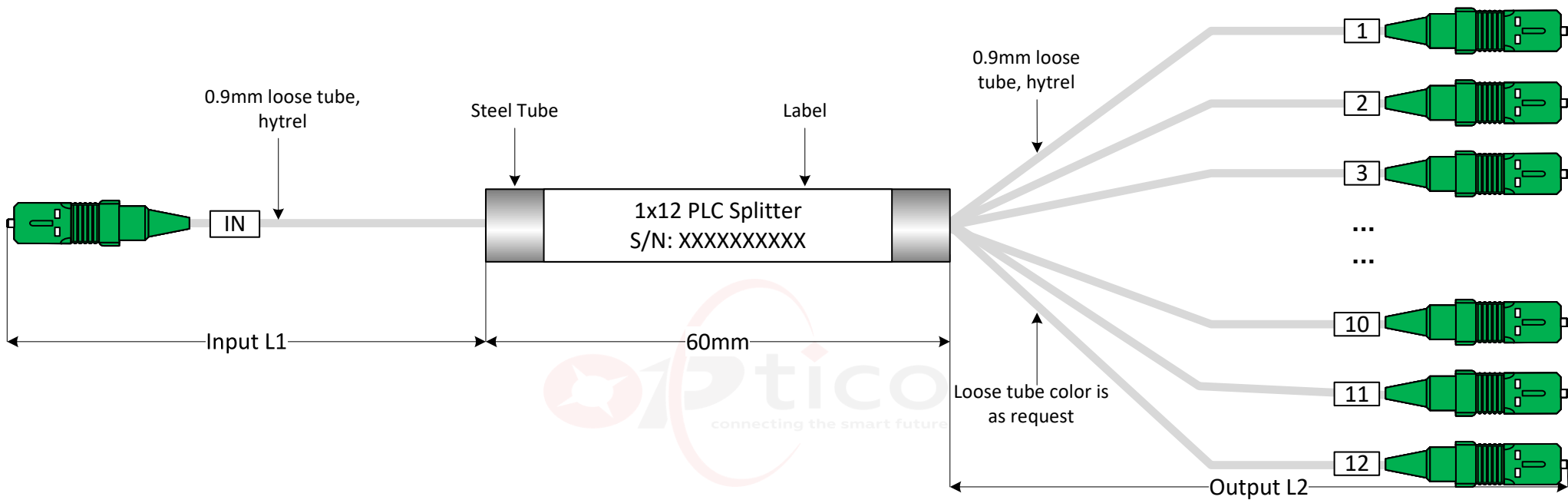

PLC Splitter Parameter		1x12
Operating Wavelength		1260~1650nm
Test Wavelength		1310/1490/1550nm
Insertion Loss	Max.	12.5dB(including connectors)
PDL	Max.	0.4 dB
Uniformity	Max.	0.8 dB
Return Loss	Min.	55 dB
Directivity	Min.	55 dB
Operating Temperature		-40~+85°C
Storage Temperature		-40~+85°C
Fiber Type		G657A./As request
Connector Type		SCAPC/As request
Steel Tube Dimension		60*7*4mm

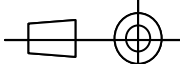
		SHENZHEN OPTICO COMMUNICATION CO., LTD.								
Model		PLC Splitter 1x12 Mini Type 900um loose tube with connectors					OP-112-900-XXM-SCA			
FIRST ANGLE PROJECTION 	MATERIAL	UNIT	SCALE	SIZE	SHEET	DRAWN	XUELING W	DATE	2025.06.10	
	LSZH	m	/	A4	1	CHECKED	Michael Liu	DATE	2025.06.10	
							APPROVED	STEVEN Zhang	DATE	2025.06.10

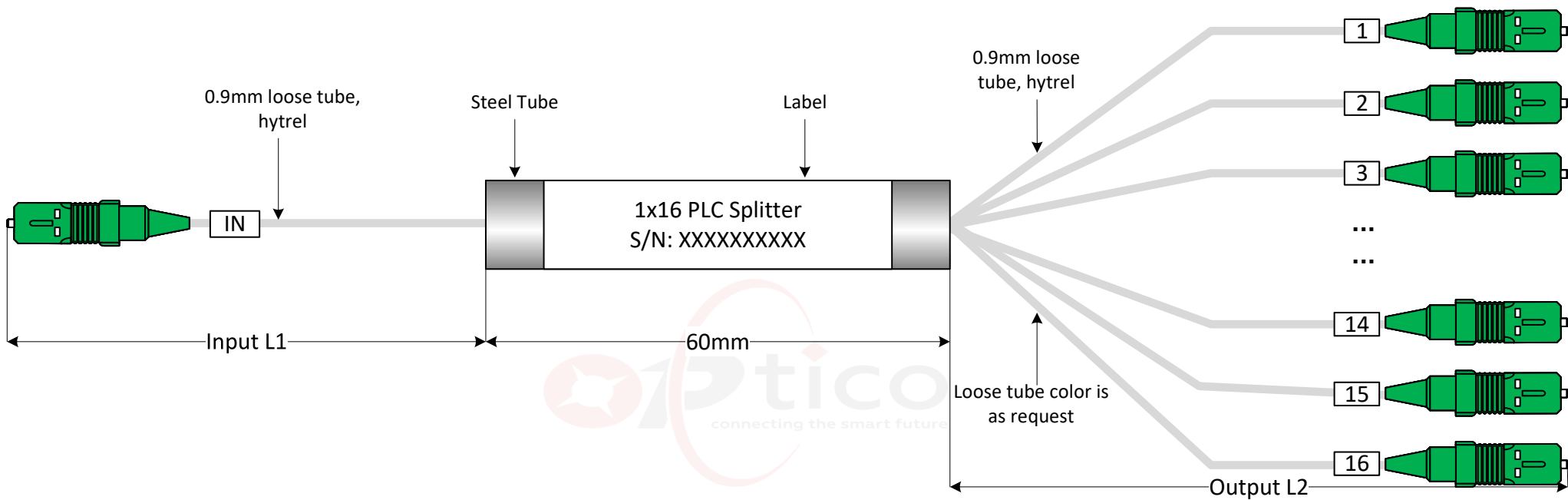

PLC Splitter Parameter		1x16
Operating Wavelength		1260~1650nm
Test Wavelength		1310/1490/1550nm
Insertion Loss	Max.	14.0dB(including connectors)
PDL	Max.	0.3 dB
Uniformity	Max.	1.0 dB
Return Loss	Min.	55 dB
Directivity	Min.	55 dB
Operating Temperature		-40~+85°C
Storage Temperature		-40~+85°C
Fiber Type		G657A./As request
Connector Type		SCAPC/As request
Steel Tube Dimension		60*12*4mm

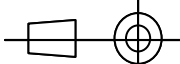
 SHENZHEN OPTICO COMMUNICATION CO., LTD.									
Model	PLC Splitter 1x16 Mini Type 900um loose tube with connectors	OP-116-900-XXM-SCA							
FIRST ANGLE PROJECTION 	MATERIAL	UNIT	SCALE	SIZE	SHEET	DRAWN	XUELING W	DATE	2025.06.10
	LSZH	m	/	A4	1	CHECKED	Michael Liu	DATE	2025.06.10
						APPROVED	STEVEN Zhang	DATE	2025.06.10

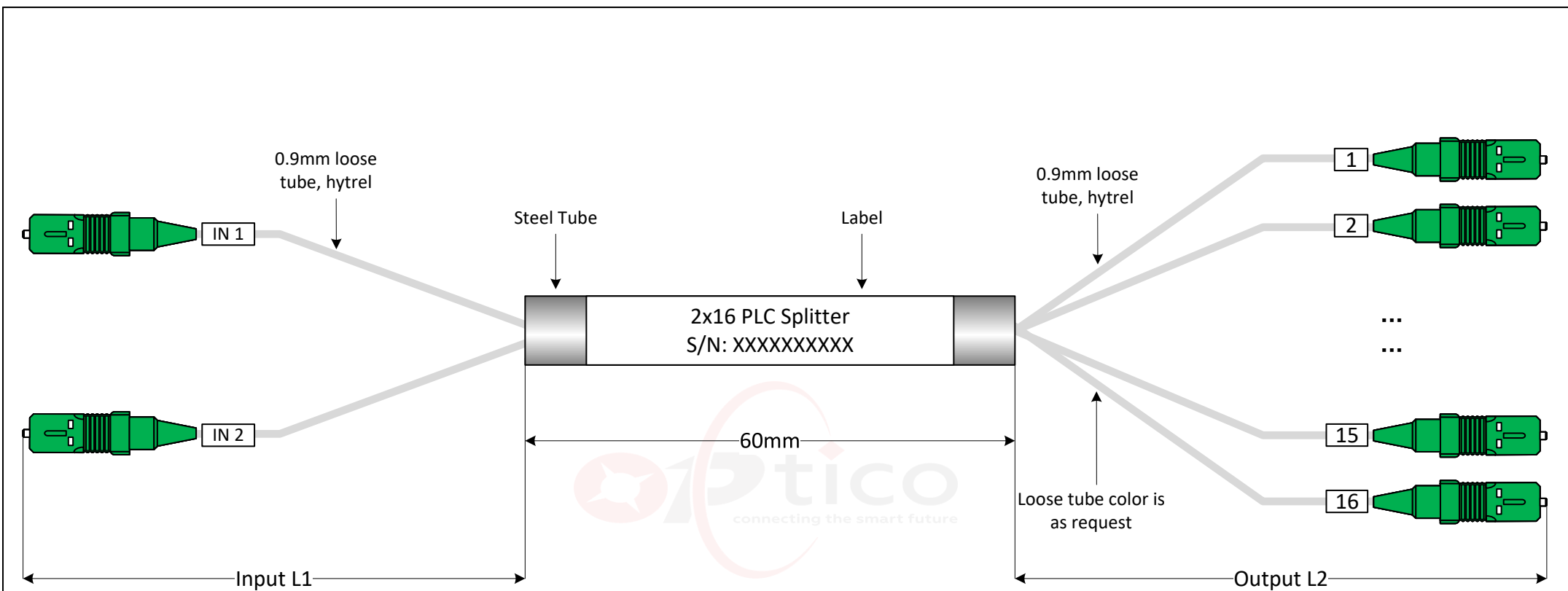

PLC Splitter Parameter		2x16
Operating Wavelength		1260~1650nm
Test Wavelength		1310/1490/1550nm
Insertion Loss	Max.	14.6 dB (including connectors)
PDL	Max.	0.3 dB
Uniformity	Max.	2.0 dB
Return Loss	Min.	55 dB
Directivity	Min.	55 dB
Operating Temperature		-40~+85°C
Storage Temperature		-40~+85°C
Fiber Type		G657A./As request
Connector Type		SCAPC/As request
Steel Tube Dimension		60*12*4mm

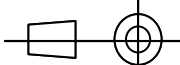
 SHENZHEN OPTICO COMMUNICATION CO., LTD.									
Model	PLC Splitter 2x16 Mini Type 900um loose tube with connectors	OP-216-900-XXM-SCA							
FIRST ANGLE PROJECTION 	MATERIAL	UNIT	SCALE	SIZE	SHEET	DRAWN	XUELING W	DATE	2025.06.10
	LSZH	m	/	A4	1	CHECKED	Michael Liu	DATE	2025.06.10
							APPROVED	STEVEN Zhang	DATE

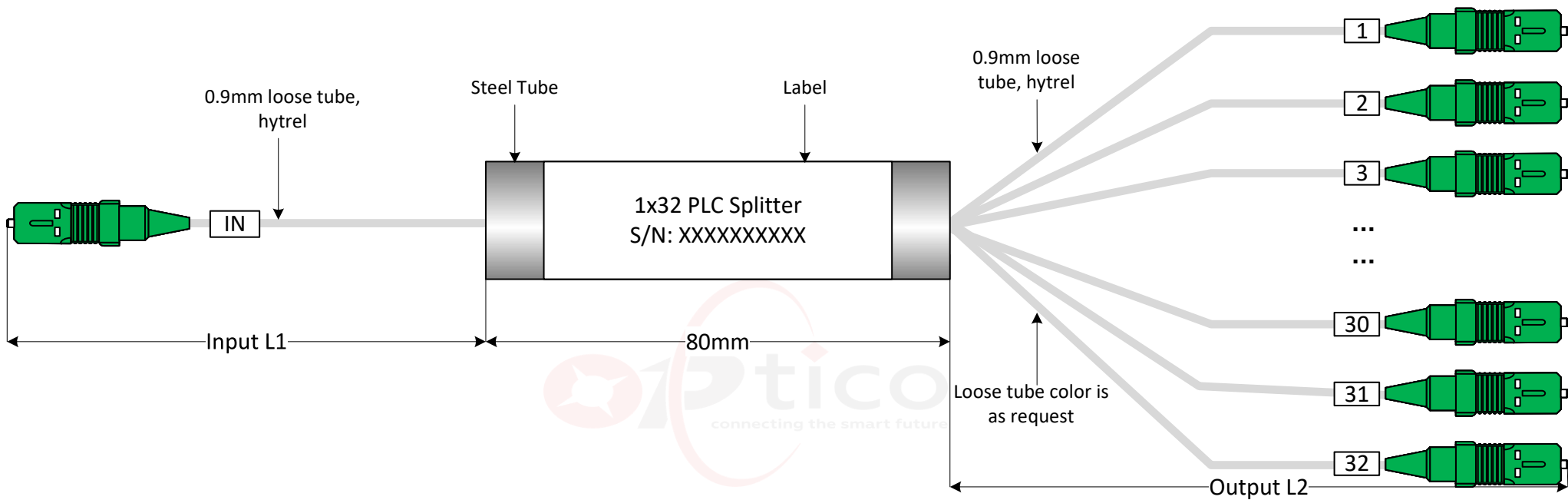

PLC Splitter Parameter		1x32
Operating Wavelength		1260~1650nm
Test Wavelength		1310/1490/1550nm
Insertion Loss	Max.	17.3dB(including connectors)
PDL	Max.	0.3 dB
Uniformity	Max.	1.5 dB
Return Loss	Min.	55 dB
Directivity	Min.	55 dB
Operating Temperature		-40~+85°C
Storage Temperature		-40~+85°C
Fiber Type		G657A./As request
Connector Type		SCAPC/As request
Steel Tube Dimension		80*20*6mm

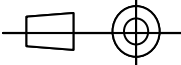
		SHENZHEN OPTICO COMMUNICATION CO., LTD.										
Model		PLC Splitter 1x32 Mini Type 900um loose tube with connectors					OP-132-900-XXM-SCA					
FIRST ANGLE PROJECTION 	MATERIAL		UNIT		SCALE		SIZE		SHEET		DRAWN	
	LSZH		m		/		A4		1		XUELING W	
											DATE	
										2025.06.10		
										CHECKED		
										Michael Liu		
										DATE		
										2025.06.10		
										APPROVED		
										STEVEN Zhang		
										DATE		
										2025.06.10		

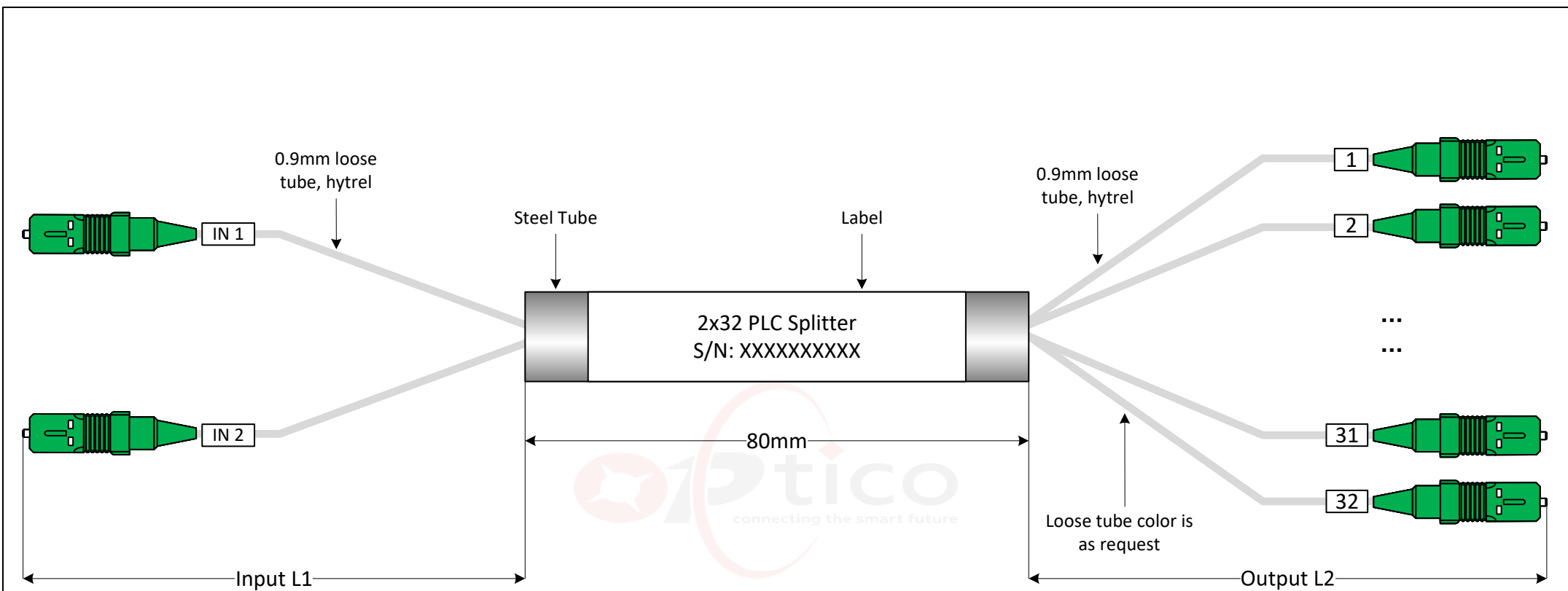

PLC Splitter Parameter		2x32
Operating Wavelength		1260~1650nm
Test Wavelength		1310/1490/1550nm
Insertion Loss	Max.	18.1 dB (including connectors)
PDL	Max.	0.3 dB
Uniformity	Max.	2.0 dB
Return Loss	Min.	55 dB
Directivity	Min.	55 dB
Operating Temperature		-40~+85°C
Storage Temperature		-40~+85°C
Fiber Type		G657A./As request
Connector Type		SCAPC/As request
Steel Tube Dimension		80*20*6mm

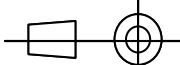
 SHENZHEN OPTICO COMMUNICATION CO., LTD.									
Model	PLC Splitter 2x32 Mini Type 900um loose tube with connectors	OP-232-900-XXM-SCA							
FIRST ANGLE PROJECTION 	MATERIAL	UNIT	SCALE	SIZE	SHEET	DRAWN	XUELING W	DATE	2025.06.10
	LSZH	m	/	A4	1	CHECKED	Michael Liu	DATE	2025.06.10
						APPROVED	STEVEN Zhang	DATE	2025.06.10

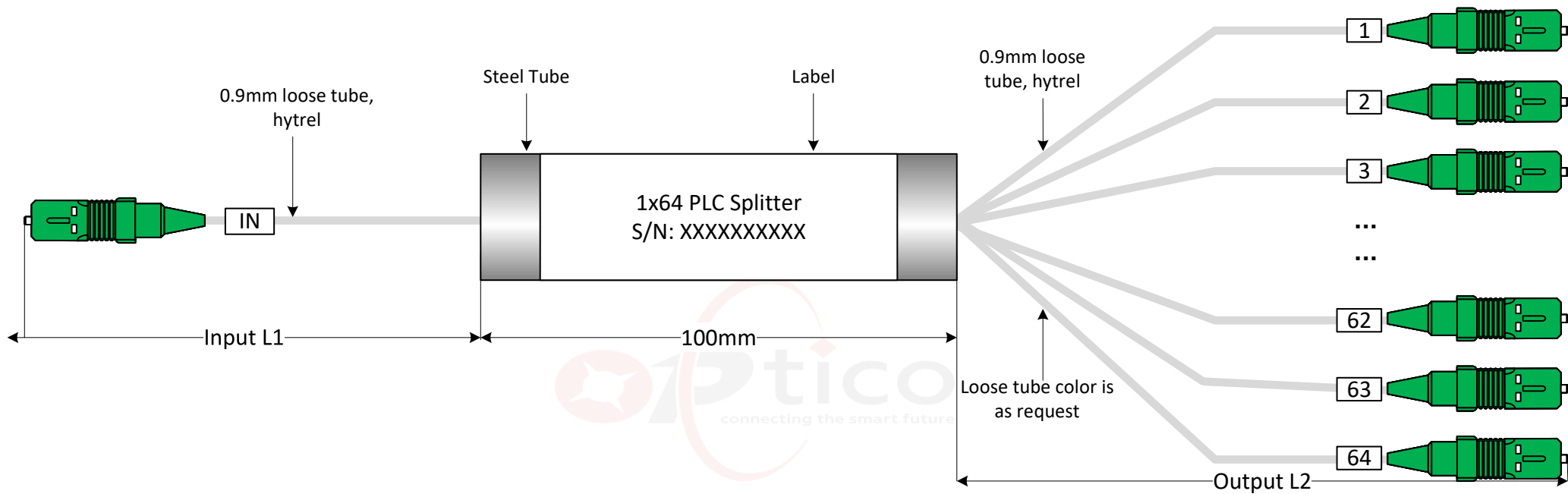

PLC Splitter Parameter		1x64
Operating Wavelength		1260~1650nm
Test Wavelength		1310/1490/1550nm
Insertion Loss	Max.	21dB(including connectors)
PDL	Max.	0.35 dB
Uniformity	Max.	2.0 dB
Return Loss	Min.	55 dB
Directivity	Min.	55 dB
Operating Temperature		-40~+85°C
Storage Temperature		-40~+85°C
Fiber Type		G657A./As request
Connector Type		SCAPC/As request
Steel Tube Dimension		100*40*6mm

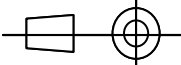
 SHENZHEN OPTICO COMMUNICATION CO., LTD.																																
Model	PLC Splitter 1x64 Mini Type 900um loose tube with connectors	OP-164-900-XXM-SCA																														
FIRST ANGLE PROJECTION 	<table border="1"> <tr> <th>MATERIAL</th> <th>UNIT</th> <th>SCALE</th> <th>SIZE</th> <th>SHEET</th> <th>DRAWN</th> </tr> <tr> <td>LSZH</td> <td>m</td> <td>/</td> <td>A4</td> <td>1</td> <td>XUELING W</td> </tr> <tr> <td colspan="5"></td> <td>CHECKED</td> </tr> <tr> <td colspan="5"></td> <td>APPROVED</td> </tr> </table>	MATERIAL	UNIT	SCALE	SIZE	SHEET	DRAWN	LSZH	m	/	A4	1	XUELING W						CHECKED						APPROVED	<table border="1"> <tr> <th>DATE</th> <td>2025.06.10</td> </tr> <tr> <th>DATE</th> <td>2025.06.10</td> </tr> <tr> <th>DATE</th> <td>2025.06.10</td> </tr> </table>	DATE	2025.06.10	DATE	2025.06.10	DATE	2025.06.10
	MATERIAL	UNIT	SCALE	SIZE	SHEET	DRAWN																										
	LSZH	m	/	A4	1	XUELING W																										
					CHECKED																											
					APPROVED																											
DATE	2025.06.10																															
DATE	2025.06.10																															
DATE	2025.06.10																															
						Michael Liu STEVEN Zhang																										

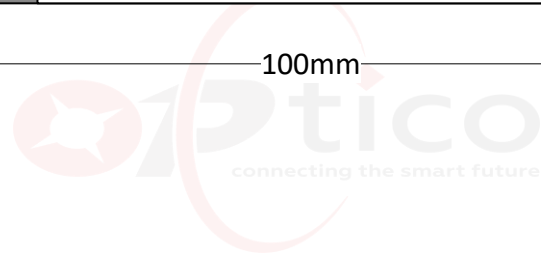
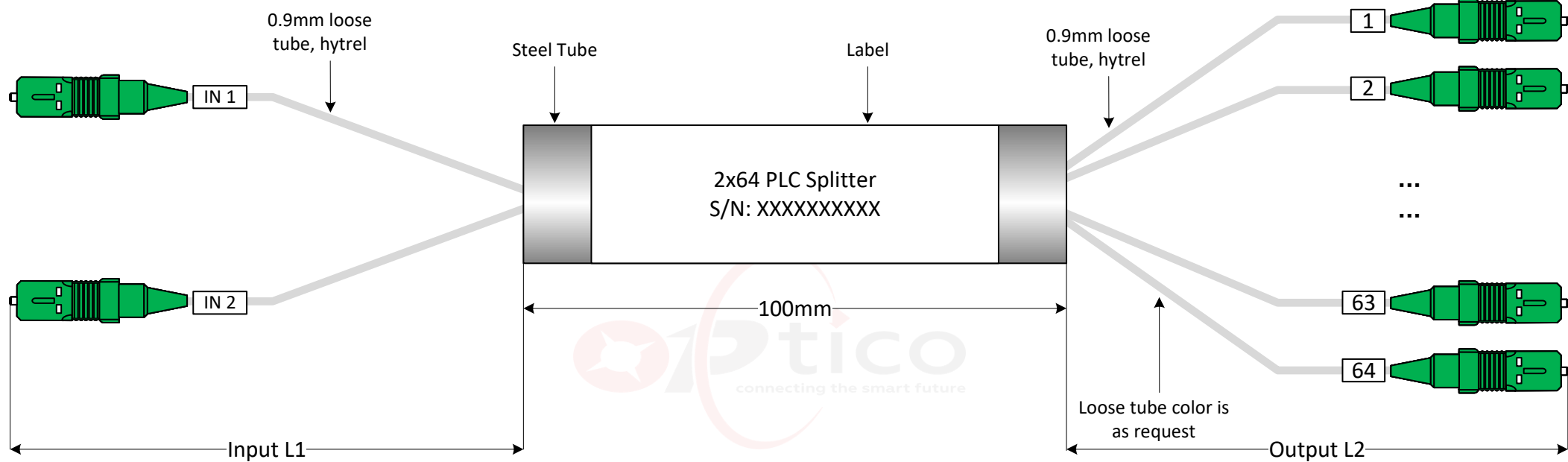

PLC Splitter Parameter		2x64
Operating Wavelength		1260~1650nm
Test Wavelength		1310/1490/1550nm
Insertion Loss	Max.	21.6 dB (including connectors)
PDL	Max.	0.5 dB
Uniformity	Max.	2.5 dB
Return Loss	Min.	55 dB
Directivity	Min.	55 dB
Operating Temperature		-40~+85°C
Storage Temperature		-40~+85°C
Fiber Type		G657A./As request
Connector Type		SCAPC/As request
Steel Tube Dimension		100*40*6mm

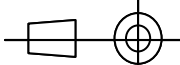
 SHENZHEN OPTICO COMMUNICATION CO., LTD.									
Model	PLC Splitter 2x64 Mini Type 900um loose tube with connectors	OP-264-900-XXM-SCA							
FIRST ANGLE PROJECTION 	MATERIAL	UNIT	SCALE	SIZE	SHEET	DRAWN	XUELING W	DATE	2025.06.10
	LSZH	m	/	A4	1	CHECKED	Michael Liu	DATE	2025.06.10
						APPROVED	STEVEN Zhang	DATE	2025.06.10

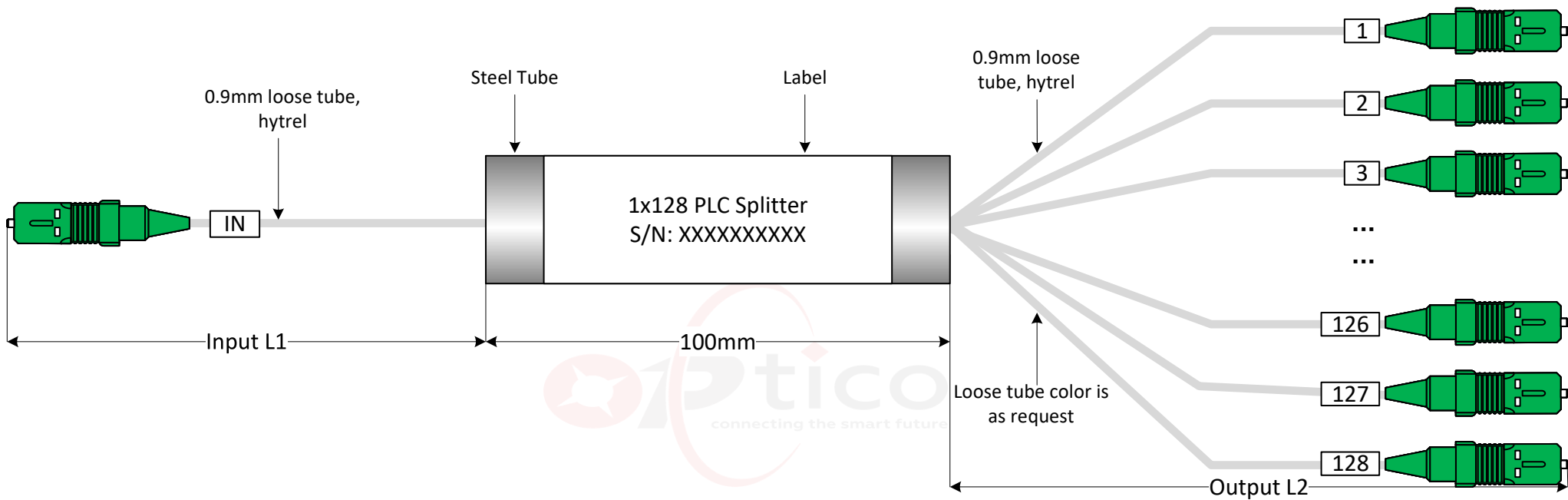

PLC Splitter Parameter		1x128
Operating Wavelength		1260~1650nm
Test Wavelength		1310/1490/1550nm
Insertion Loss	Max.	23.5dB(including connectors)
PDL	Max.	0.35 dB
Uniformity	Max.	2.0 dB
Return Loss	Min.	55 dB
Directivity	Min.	55 dB
Operating Temperature		-40~+85°C
Storage Temperature		-40~+85°C
Fiber Type		G657A./As request
Connector Type		SCAPC/As request
Dimension		100*80*10mm

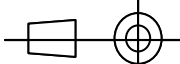
 SHENZHEN OPTICO COMMUNICATION CO., LTD.									
Model	PLC Splitter 1x128 Mini Type 900um loose tube with connectors	OP-1128-900-XXM-SCA							
FIRST ANGLE PROJECTION 	MATERIAL	UNIT	SCALE	SIZE	SHEET	DRAWN	XUELING W	DATE	2025.06.10
	LSZH	m	/	A4	1	CHECKED	Michael Liu	DATE	2025.06.10
						APPROVED	STEVEN Zhang	DATE	2025.06.10